

Company: Lamont Doherty

Well: Expedition 307 Site U1307D

Field: Porcupine Basin Carbonate Mounds

Rig: Joides Resolution Country: Ireland

Well Seismic Tool

Rig: Joides Resolution Field: Porcupine Basin Carbonate Mounds Location: Expedition 307 Site U1307D Well: Expedition 307 Site U1307D Company: Lamont Doherty		Well Seismic Tool	
LOCATION			
Permanent Datum: _____ Mean Sea Level _____ Log Measured From: _____ Drill Floor _____ Drilling Measured From: _____ Drill Floor _____		Elev.: K.B. 11.3 m G.L. -805 m D.F. 11 m	
Ocean Atlantic		Max. Well Deviation Longitude 11° 43.09W Latitude 51° 22.83N	

Logging Date	6-May-2005	
Run Number	One	
Depth Driller	1075 m	
Schlumberger Depth	1075 m	
Bottom Log Interval	1055 m	
Top Log Interval	905 m	
Casing Driller Size @ Depth	0.000 in @ 892 m	
Casing Schlumberger	893 m	
Bit Size	9.875 in	
Type Fluid In Hole	Sepiolite	
Density	1.07 g/cm3	
Fluid Loss	PH	
Source Of Sample		
RM @ Measured Temperature	0.322 ohm.m @ 22 degC	
RMF @ Measured Temperature	@ @	
RMC @ Measured Temperature	@ @	
Source RMF	RMC	
RM @ MRT	0.362 @ 18 @ 18	
Maximum Recorded Temperatures	18 degC	
Circulation Stopped	Time	
Logger On Bottom	6-May-2005 Time 18:30	
Unit Number	2082 Location Webster, TX	
Recorded By	Javier Espinosa	
Witnessed By	Phillipe Gaillot	

Logging Date			Run 1	Run 2	Run
Run Number					
Depth Driller					
Schlumberger Depth					
Bottom Log Interval					
Top Log Interval					
Casing Driller Size @ Depth					
Casing Schlumberger					
Bit Size					
Type Fluid In Hole					
Density					
Fluid Loss					
Source Of Sample					
RM @ Measured Temperature			@	@	@
RMF @ Measured Temperature			@	@	@
RMC @ Measured Temperature			@	@	@
Source RMF					
RM @ MRT			@	@	@
Maximum Recorded Temperatures					
Circulation Stopped					
Logger On Bottom					
Unit Number					
Recorded By					
Witnessed By					

DISCLAIMER

THE USE OF AND RELIANCE UPON THIS RECORDED-DATA BY THE HEREIN NAMED COMPANY (AND ANY OF ITS AFFILIATES, PARTNERS, REPRESENTATIVES, AGENTS, CONSULTANTS AND EMPLOYEES) IS SUBJECT TO THE TERMS AND CONDITIONS AGREED UPON BETWEEN SCHLUMBERGER AND THE COMPANY, INCLUDING: (a) RESTRICTIONS ON USE OF THE RECORDED-DATA; (b) DISCLAIMERS AND WAIVERS OF WARRANTIES AND REPRESENTATIONS REGARDING COMPANY'S USE OF AND RELIANCE UPON THE RECORDED-DATA; AND (c) CUSTOMER'S FULL AND SOLE RESPONSIBILITY FOR ANY INFERENCE DRAWN OR DECISION MADE IN CONNECTION WITH THE USE OF THIS RECORDED-DATA.

OTHER SERVICES1
 OS1: TCOM
 OS2: FMS
 OS3: DSI
 OS4:
 OS5:

OTHER SERVICES2
 OS1:
 OS2:
 OS3:
 OS4:
 OS5:

REMARKS: RUN NUMBER 1
 Parameters and Presentations as per IODP standards
 Tool ras as per tool sketch below
 RCB used to core the hole
 TD not reached due to hole conditions

REMARKS: RUN NUMBER 2

RUN 1
 SERVICE ORDER #:
 PROGRAM VERSION: 12C0-301
 FLUID LEVEL:

RUN 2
 SERVICE ORDER #:
 PROGRAM VERSION:
 FLUID LEVEL:

LOGGED INTERVAL	START	STOP

LOGGED INTERVAL	START	STOP

EQUIPMENT DESCRIPTION

RUN 1
SURFACE EQUIPMENT
 WSAM
 OPTION
 BGKT_PANEL

RUN 2

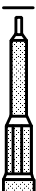
DOWNHOLE EQUIPMENT
 LEH-QT
 LEH-QT

 6.73

SAH-E
SAH-E

5.84



WSTA-A
WSTA_SONDE
OYO-GEOPHONES

4.98



WSTA Arm
Tension

— TOOL ZERO

TOOL BOTTOM

MAXIMUM STRING DIAMETER 4.63 IN
MEASUREMENTS RELATIVE TO TOOL ZERO
ALL LENGTHS IN METERS

Production String

(in)	(m)
OD	ID MD

Well Schematic

(m)	(in)
MD	OD ID

Casing String

Kelly Bushing Elevation
Derrick Floor Elevation

Mean Sea Level

Seismic Gun depth below MSL

11.3
11.0

0.0

2.0

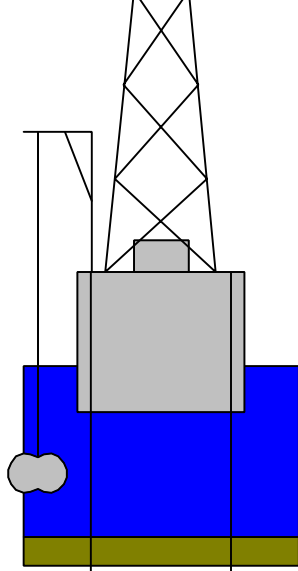

0.0 5.000

Casing String



805.0 9.875
892.0 5.000

Borehole Segment

Casing Shoe

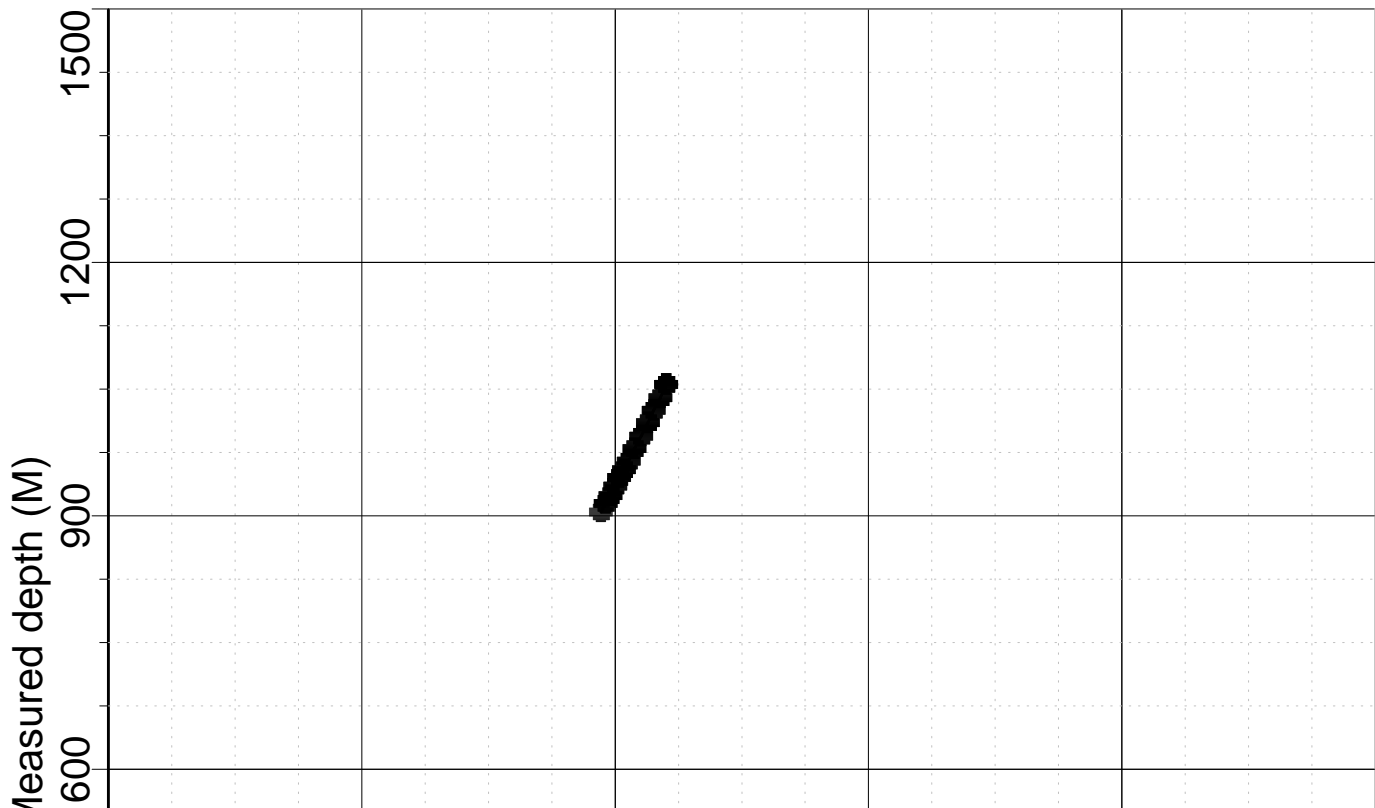

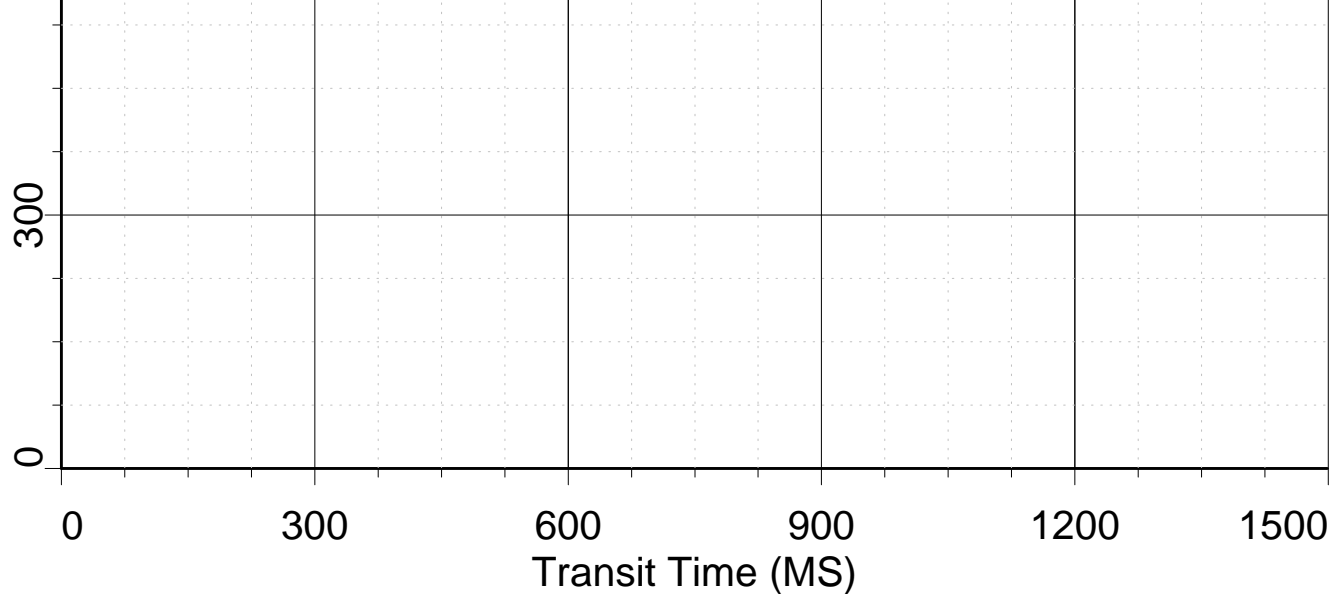

Output DLIS Files

DEFAULT	SEIS_WSS_023LNP	FN:24	PRODUCER	06-May-2005 18:30	0.0 M	0.4 M
REDUCED	SEIS_WSS_023LNP	FN:25	PRODUCER	06-May-2005 18:30	0.0 M	0.4 M

OP System Version: 12C0-301

MCM

WSTA-A 12C0-301

STACK # 13 6-May-2005-19:42 Shots: 132-133-134-135-137-141-142-143-146
 Source Offset Distance = 49.0 M Azimuth = 0.0 DEG
 Band Pass Filter = OFF-OFF Blanking Time = 100 ms

S1, pp= 62062 bits = 9470.1982 mV, Gain = 1, Break= 12.39 ms

WSTA Depth = 905.0 M , Transit Time = 583.43 ms

DZ1, pp= 65535 bits = 10000.1523 mV, Gain = 1, Break= 595.81 ms

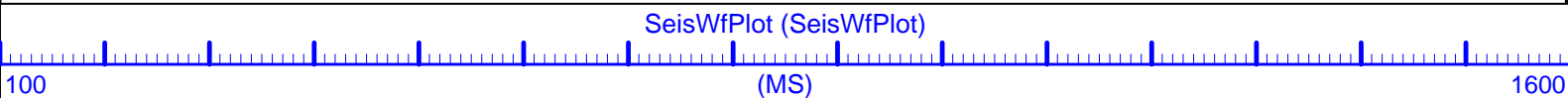

STACK # 12 6-May-2005-19:36 Shots: 123-124-125-126-127-128-129-130-131

Source Offset Distance = 49.0 M Azimuth = 0.0 DEG
Band Pass Filter = OFF-OFF Blanking Time = 100 ms

S1, pp= 61499 bits = 9384.2891 mV, Gain = 1, Break= 11.71 ms

WSTA Depth = 915.0 M , Transit Time = 589.07 ms

DZ1, pp= 54038 bits = 8245.7959 mV, Gain = 1, Break= 600.79 ms

SeisWfPlot (SeisWfPlot)

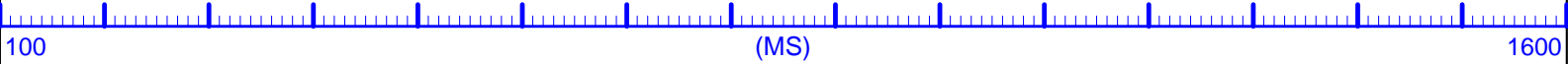

STACK # 11 6-May-2005-19:31 Shots: 114-115-116-117-118-119-120-121-122

Source Offset Distance = 49.0 M Azimuth = 0.0 DEG

Band Pass Filter = OFF-OFF Blanking Time = 100 ms

S1, pp= 61682 bits = 9412.2129 mV, Gain = 1, Break= 12.40 ms

WSTA Depth = 925.0 M , Transit Time = 594.11 ms

DZ1, pp= 59663 bits = 9104.1289 mV, Gain = 1, Break= 606.50 ms

SeisWfPlot (SeisWfPlot)

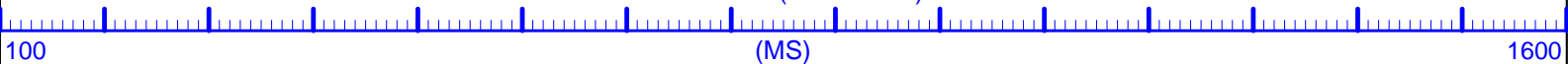

STACK # 10 6-May-2005-19:26 Shots: 105-106-107-108-109-110-111-112-113

Source Offset Distance = 49.0 M Azimuth = 0.0 DEG

Band Pass Filter = OFF-OFF Blanking Time = 100 ms

S1, pp= 62429 bits = 9526.1992 mV, Gain = 1, Break= 12.35 ms

WSTA Depth = 935.0 M , Transit Time = 599.90 ms

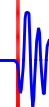

DZ1, pp= 65534 bits = 9999.9990 mV, Gain = 1, Break= 612.24 ms

SeisWfPlot (SeisWfPlot)

100

(MS)

1600

STACK # 9 6-May-2005-19:21 Shots: 96-97-98-99-100-101-102-103-104

Source Offset Distance = 49.0 M Azimuth = 0.0 DEG

Band Pass Filter = OFF-OFF Blanking Time = 100 ms

S1, pp= 60257 bits = 9194.7686 mV, Gain = 1, Break= 11.70 ms

WSTA Depth = 945.0 M , Transit Time = 605.04 ms

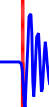

DZ1, pp= 64373 bits = 9822.8398 mV, Gain = 1, Break= 616.75 ms

SeisWfPlot (SeisWfPlot)

100

(MS)

1600

STACK # 8 6-May-2005-19:15 Shots: 87-88-89-90-91-92-93-94-95

Source Offset Distance = 49.0 M Azimuth = 0.0 DEG

Band Pass Filter = OFF-OFF Blanking Time = 100 ms

S1, pp= 62714 bits = 9569.6885 mV, Gain = 1, Break= 12.44 ms

WSTA Depth = 955.0 M , Transit Time = 610.68 ms

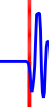

DZ1, pp= 57304 bits = 8744.1631 mV, Gain = 1, Break= 623.12 ms

STACK # 7 6-May-2005-19:11 Shots: 77-78-79-80-81-82-83-84-85-86
Source Offset Distance = 49.0 M Azimuth = 0.0 DEG
Band Pass Filter = OFF-OFF Blanking Time = 100 ms

S1, pp= 59482 bits = 9076.5098 mV, Gain = 1, Break= 11.67 ms

WSTA Depth = 965.0 M , Transit Time = 615.59 ms

DZ1, pp= 55538 bits = 8474.6846 mV, Gain = 1, Break= 627.26 ms

STACK # 6 6-May-2005-19:05 Shots: 68-69-70-71-72-73-74-75-76
Source Offset Distance = 49.0 M Azimuth = 0.0 DEG
Band Pass Filter = OFF-OFF Blanking Time = 300 ms

S1, pp= 61800 bits = 9430.2188 mV, Gain = 1, Break= 12.36 ms

WSTA Depth = 980.1 M , Transit Time = 623.52 ms

DZ1, pp= 54386 bits = 8298.8975 mV, Gain = 1, Break= 635.87 ms

SeisWfPlot (SeisWfPlot)

300 (MS) 1800

STACK # 5 6-May-2005-19:00 Shots: 59-60-61-62-63-64-65-66-67
Source Offset Distance = 49.0 M Azimuth = 0.0 DEG
Band Pass Filter = OFF-OFF Blanking Time = 100 ms

S1, pp= 62085 bits = 9473.7080 mV, Gain = 1, Break= 11.72 ms

WSTA Depth = 995.1 M , Transit Time = 630.98 ms

DZ1, pp= 48553 bits = 7408.8257 mV, Gain = 1, Break= 642.70 ms

SeisWfPlot (SeisWfPlot)

100 (MS) 1600

STACK # 4 6-May-2005-18:54 Shots: 50-51-52-53-54-55-56-57-58
Source Offset Distance = 49.0 M Azimuth = 0.0 DEG
Band Pass Filter = OFF-OFF Blanking Time = 300 ms

S1, pp= 61806 bits = 9431.1348 mV, Gain = 1, Break= 12.33 ms

WSTA Depth = 1010.0 M , Transit Time = 638.49 ms

DZ1, pp= 52867 bits = 8067.1099 mV, Gain = 1, Break= 650.83 ms

SeisWfPlot (SeisWfPlot)

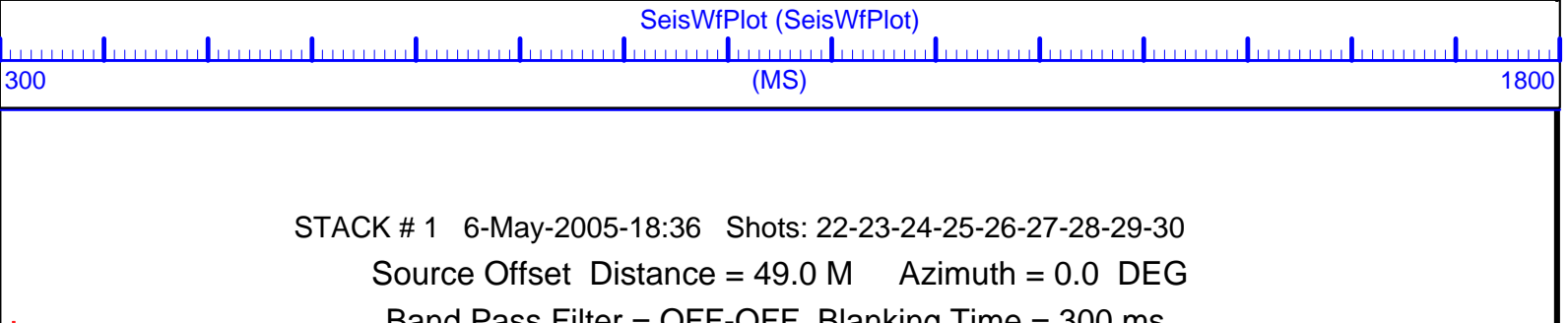
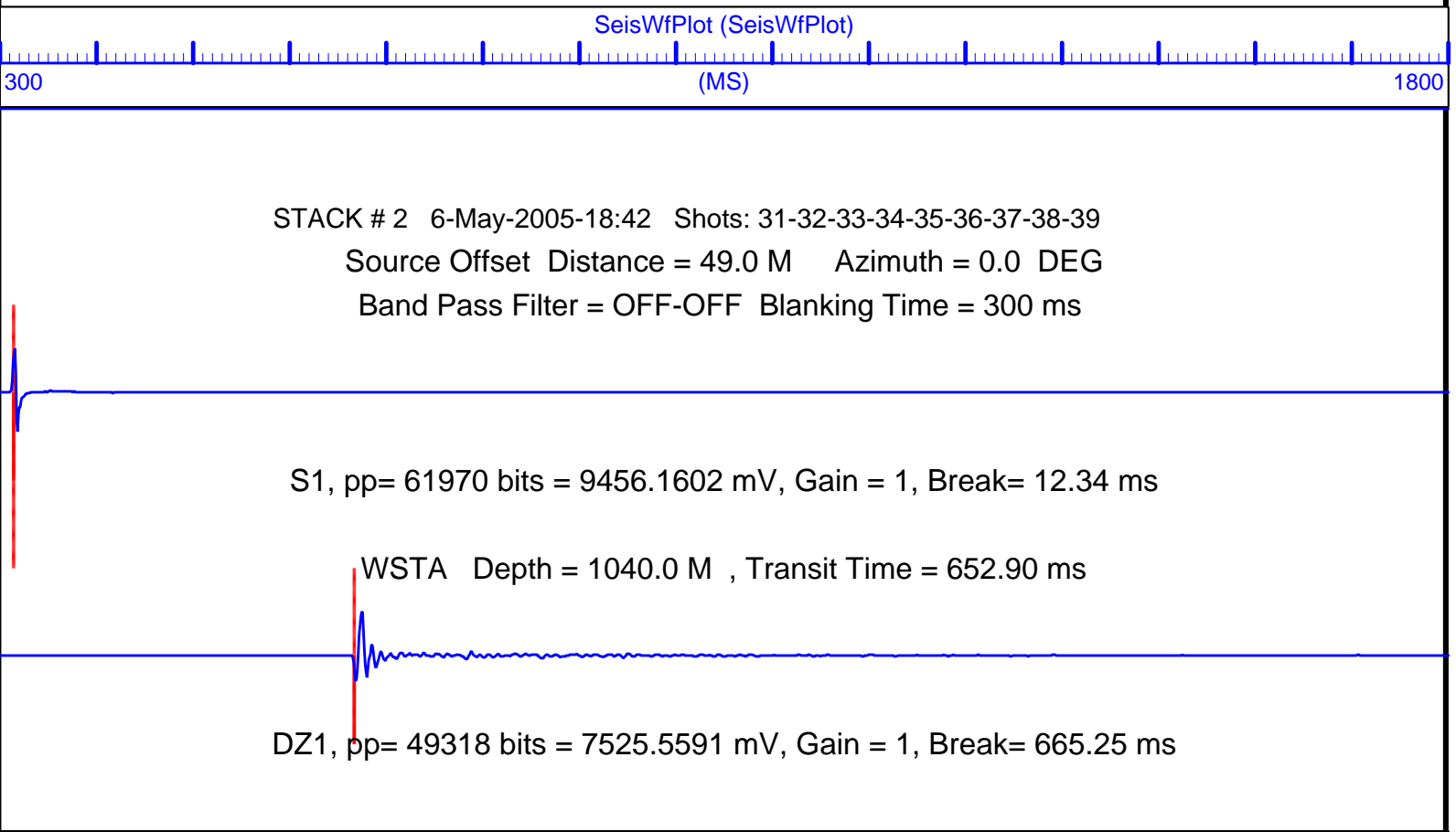
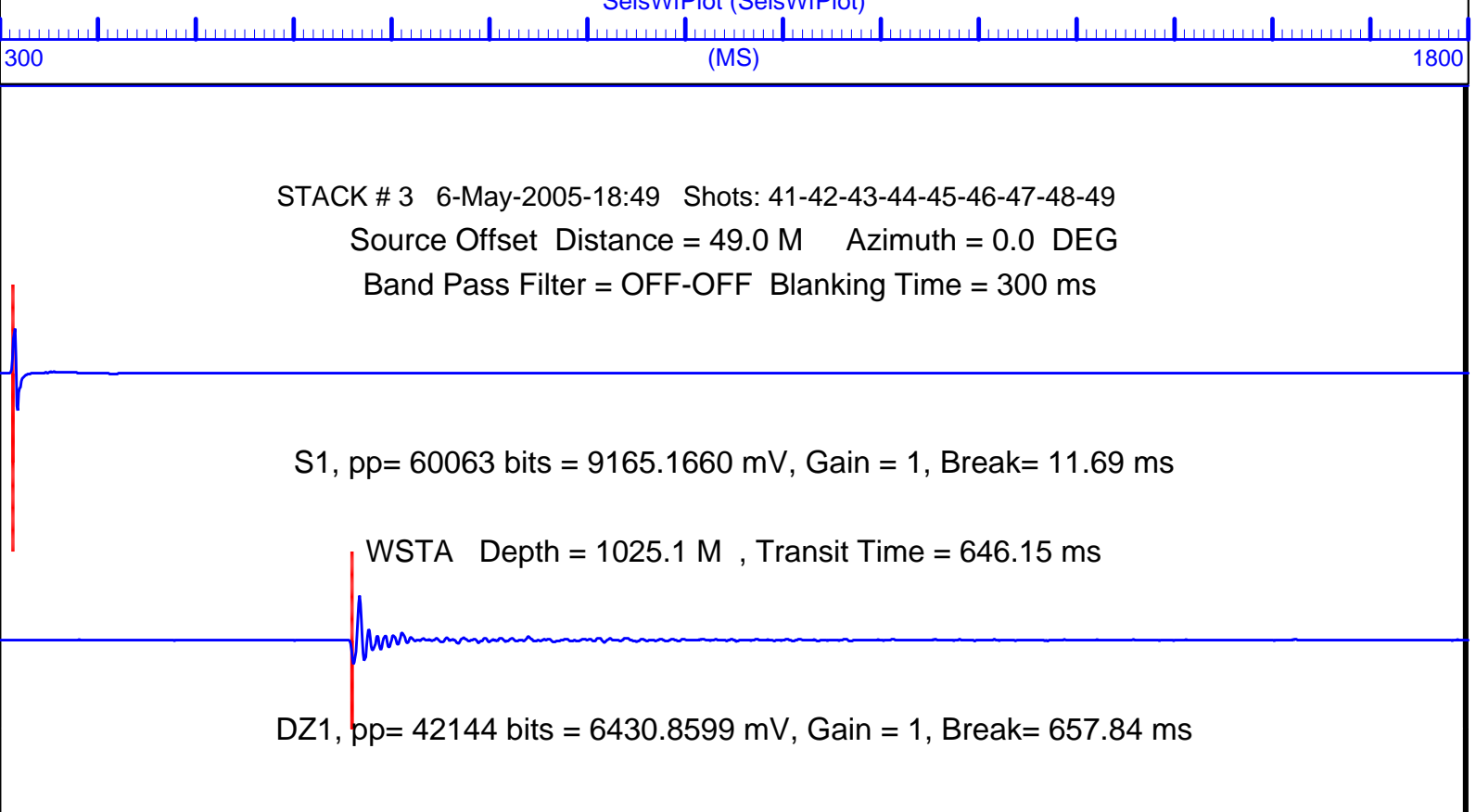

S1, pp= 59751 bits = 9117.5566 mV, Gain = 1, Break= 11.70 ms

WSTA Depth = 1056.0 M , Transit Time = 660.29 ms

DZ1, pp= 58969 bits = 8998.2295 mV, Gain = 1, Break= 671.99 ms

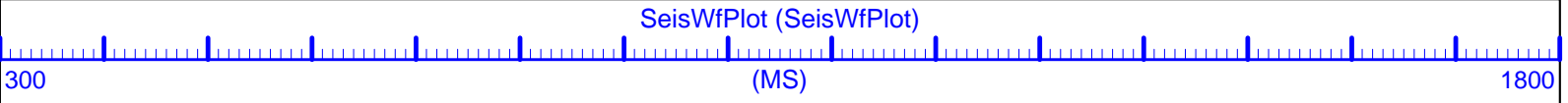

Format: SeisAxisWfPlotSat Vertical Scale: 0.5" per 1SAMPLES Graphics File Created: 06-May-2005 18:30

OP System Version: 12C0-301
MCM

WSTA-A 12C0-301

Output DLIS Files

DEFAULT	SEIS_WSS_023LNP	FN:24	PRODUCER	06-May-2005 18:30
REDUCED	SEIS_WSS_023LNP	FN:25	PRODUCER	06-May-2005 18:30

Company: Lamont Doherty



Well: Expedition 307 Site U1307D
 Field: Porcupine Basin Carbonate Mounds
 Rig: Joides Resolution
 Country: Ireland

Well Seismic Tool