

ALL INTERPRETATIONS ARE OPINIONS BASED ON INFERENCES FROM ELECTRICAL OR OTHER MEASUREMENTS AND WE CANNOT, AND DO NOT GUARANTEE THE ACCURACY OR CORRECTNESS OF ANY INTERPRETATIONS, AND WE SHALL NOT, EXCEPT IN THE CASE OF GROSS OR WILLFUL NEGLIGENCE ON OUR PART, BE LIABLE OR RESPONSIBLE FOR ANY LOSS, COSTS, DAMAGES OR EXPENSES INCURRED OR SUSTAINED BY ANYONE RESULTING FROM ANY INTERPRETATION MADE BY ANY OF OUR OFFICERS, AGENTS OR EMPLOYEES. THESE INTERPRETATIONS ARE ALSO SUBJECT TO CLAUSE 4 OF OUR GENERAL TERMS AND CONDITIONS AS SET OUT IN OUR CURRENT PRICE SCHEDULE.

OTHER SERVICES1
 OS1: DITE/HNGS/HLDS/APS
 OS2: GHMT
 OS3:
 OS4:
 OS5:

OTHER SERVICES2
 OS1:
 OS2:
 OS3:
 OS4:
 OS5:

REMARKS: RUN NUMBER 1
 Hole cored with RCB.
 Sea Floor at 2631 mbrf.
 Log presented in meters below rig floor.
 Lamont Temperature Tool (TAP) run on DITE/HLDS/APS/HNGS only.
 Wireline Heave Compensator used on all descents. Wireline heave compensator went out of range due to heavy heave conditions at 3388-3355, 3349-3154, 3144-2953, 2952-2887, 2891-end of log.
 Sepiolite mud placed in the hole before logging.
 Drillers TD-3399.85 mbrf.
 Loggers TD-3395 mbrf.
 Drill Pipe Logger- 2782 mbrf.
 Power fluctuation with DSI below 200 v caused absence of data at 2911-2908mbrf.
 The repeat covers this depth. Low Frequency Dipole provided best shear DT.

REMARKS: RUN NUMBER 2

RUN 1		
LOGGED INTERVAL	START	STOP



RUN 2		
LOGGED INTERVAL	START	STOP

EQUIPMENT DESCRIPTION

RUN 1
SURFACE EQUIPMENT
 GSR-U
 WITM (DTS)-A

RUN 2

DOWNHOLE EQUIPMENT

LEH-QT			32.09
LEH-QT			
DTC-H	CTEM		30.92
ECH-KC 8253	TelStatus		31.20
	ToolStatu		30.29
AH-CMEAY			30.29
AH-CMEAY 765			

DSST-B 29.00
 SPAC-B 18
 ECH-SD 18
 SMDR-BD 8070
 SSIJ-BA 65
 SMDX-AA 8026

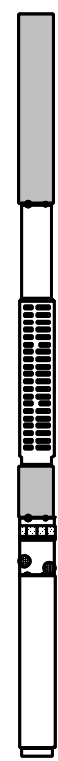

PWF 13.45

AH-CMEAY 13.45
 AH-CMEAY 764

DTA-A 12.16
 ECH-KE 8261
 DTA-A 8261

Detector 10.94
 NGT-C 10.56
 NGD-A 1736
 NGH-B 3
 NGC-C 1921
 NGCH-A 752

GHMT-A 8.33
 GHMC-B 701
 ECH-MBA 701
 NMTE-C 703
 SUMS-B 702
 NMRS-C 702

SUMS 4.08

NMRS 1.07

STATUS HV DF 0.00
 Tension

BNS-CCS 0.14
 TOOL ZERO

MAXIMUM STRING DIAMETER 4.00 IN
 MEASUREMENTS RELATIVE TO TOOL ZERO
 ALL LENGTHS IN METERS

Output DLIS Files

DEFAULT	GHMT .018	FN:29 PRODUCER	03-May-2000 02:29	3394.1 M	2772.2 M
GHMT_CUST	GHMT .018	FN:30 PRODUCER	03-May-2000 02:29	3394.1 M	2772.2 M

OP System Version: 9C1-303

MCM

GHMT-A	9C1-303	NGT-C	9C1-303
DTA-A	9C1-303	DSST-B	9C1-303
DTC-H	9C1-303		

PIP SUMMARY

- └ Integrated Transit Time Minor Pip Every 1 MS
- └ Integrated Transit Time Major Pip Every 10 MS

▶ Time Mark Every 60 S

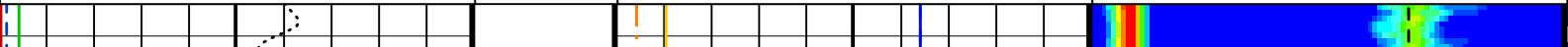
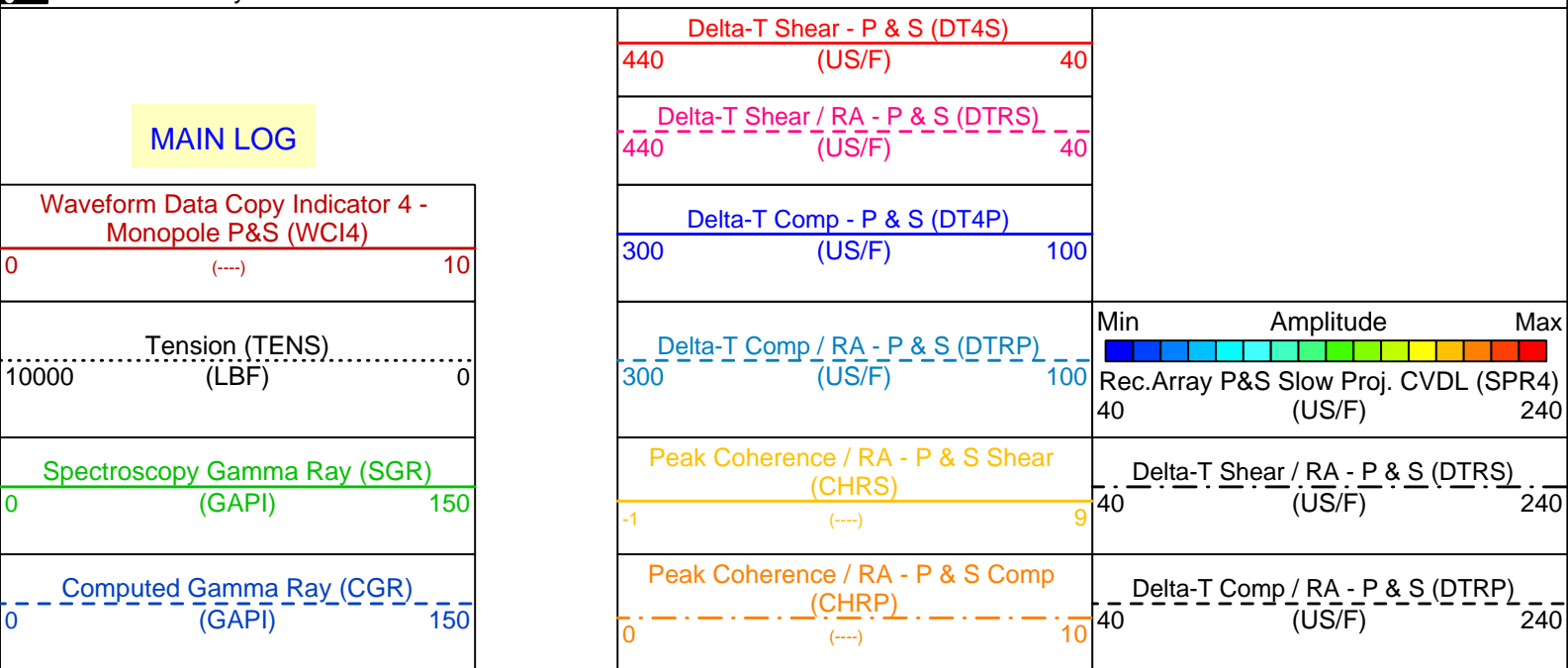

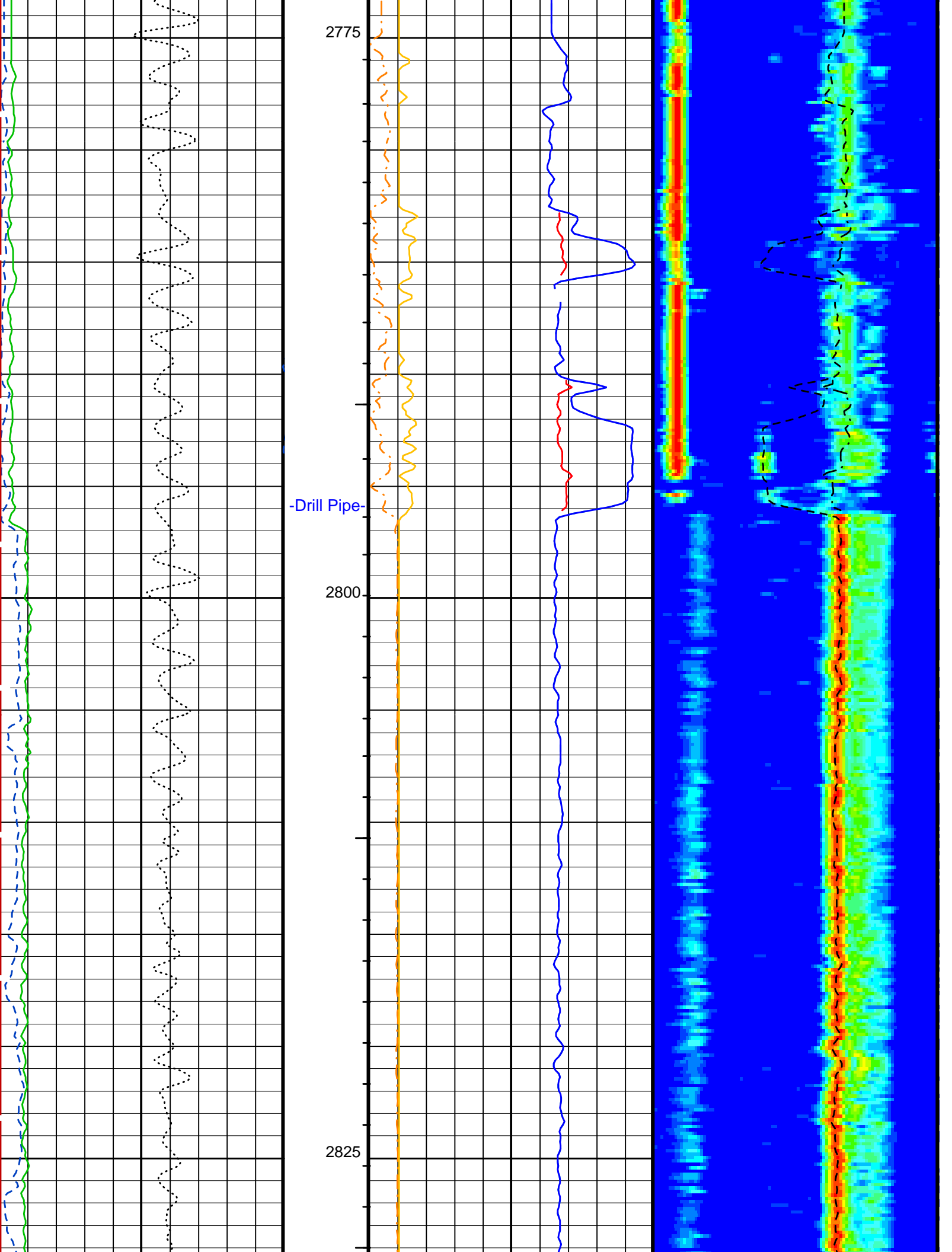

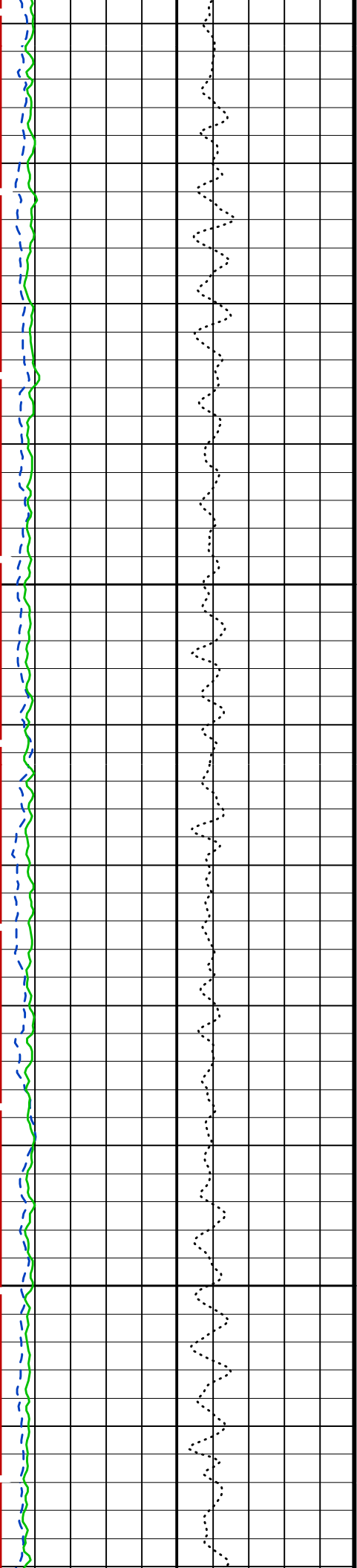

2850

2875

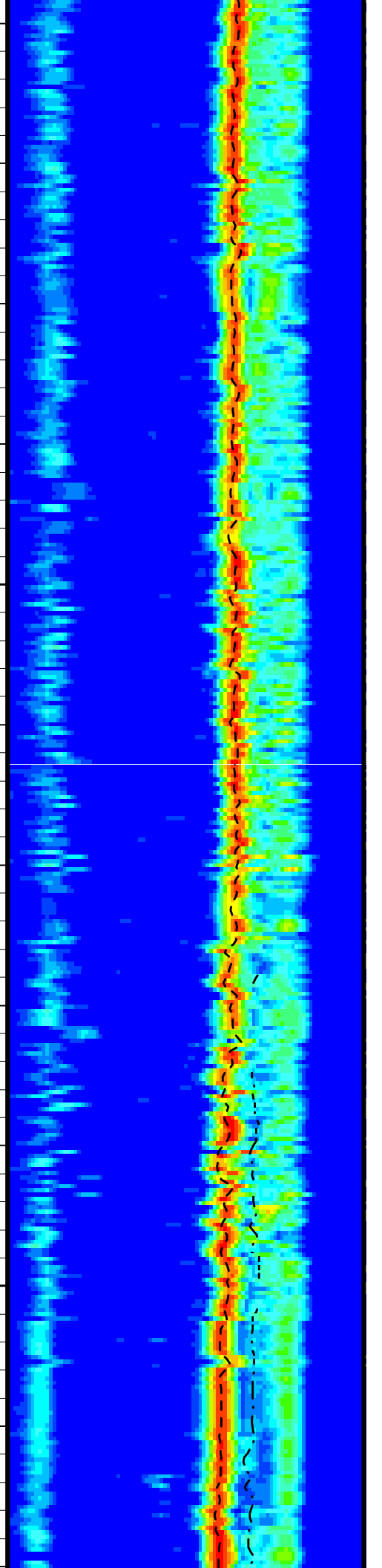
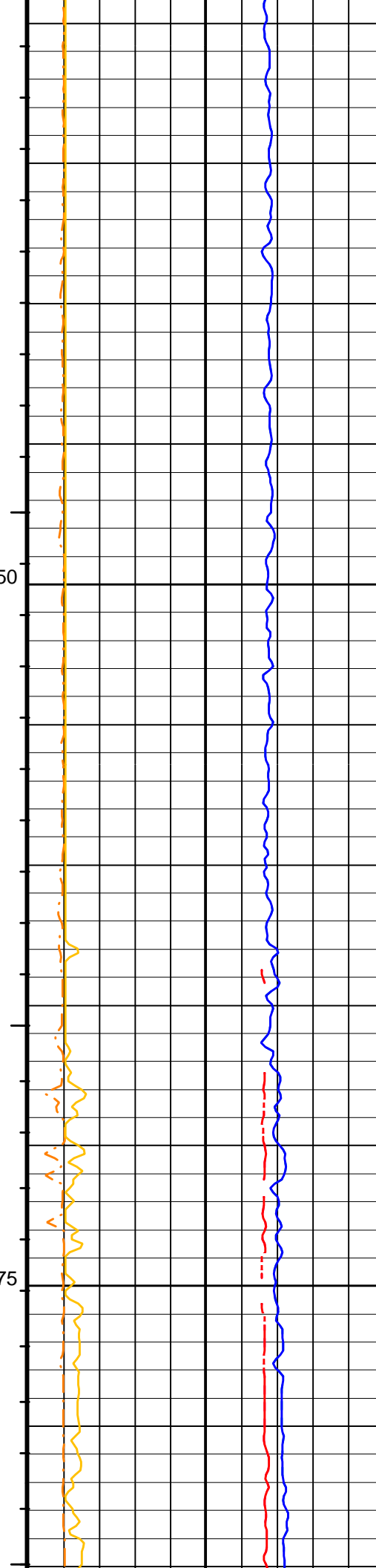

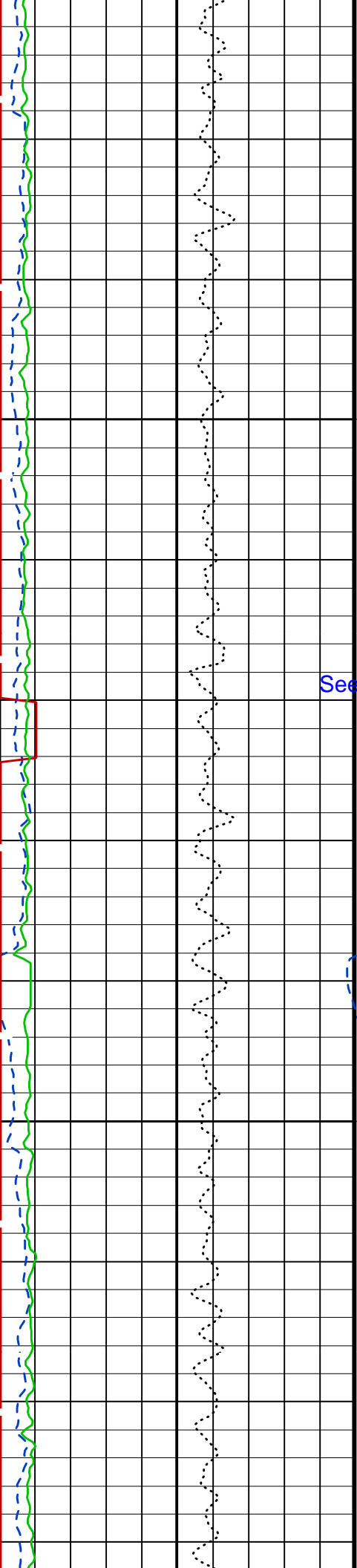

See Remarks

2900

2925

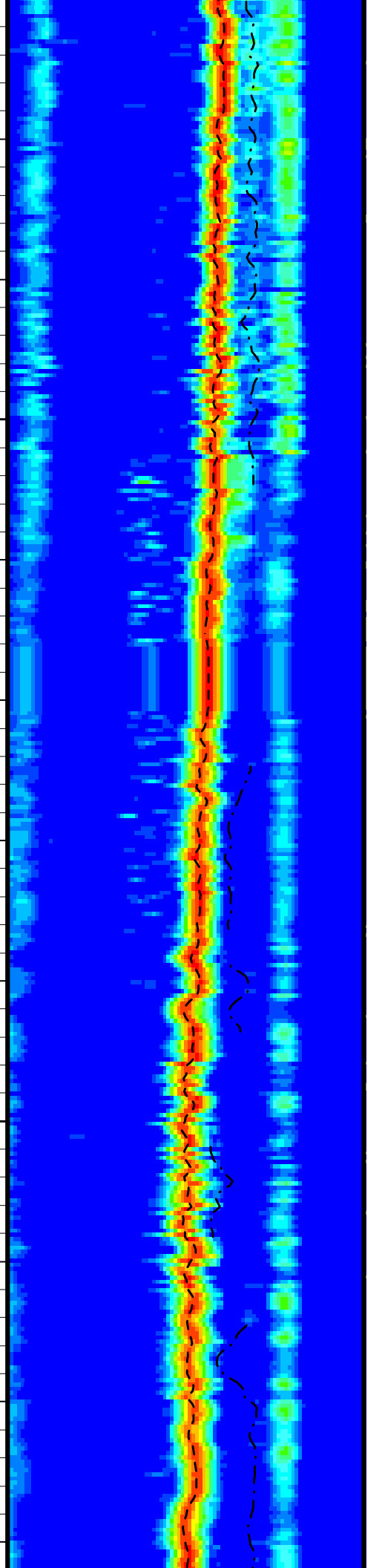
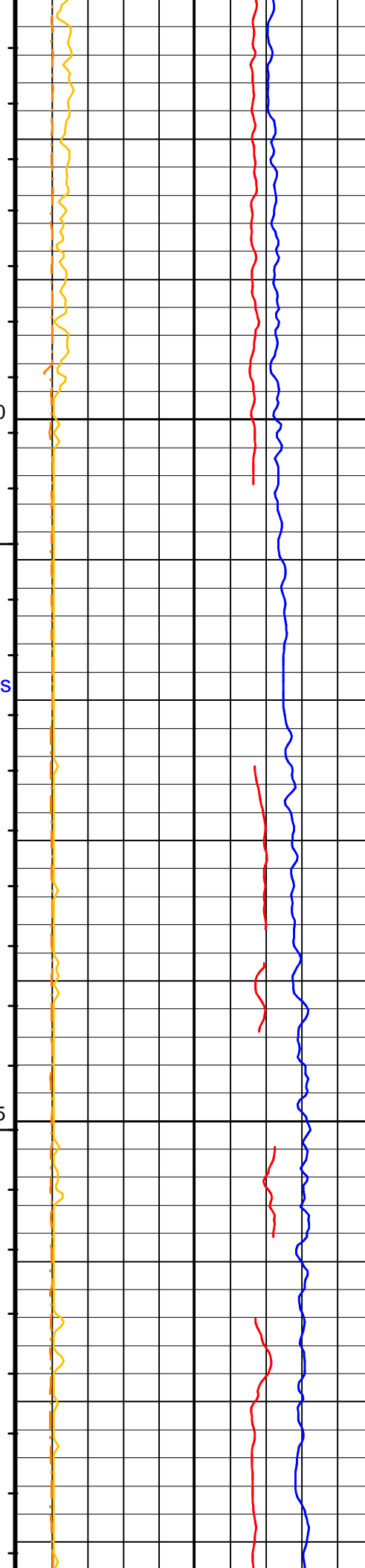

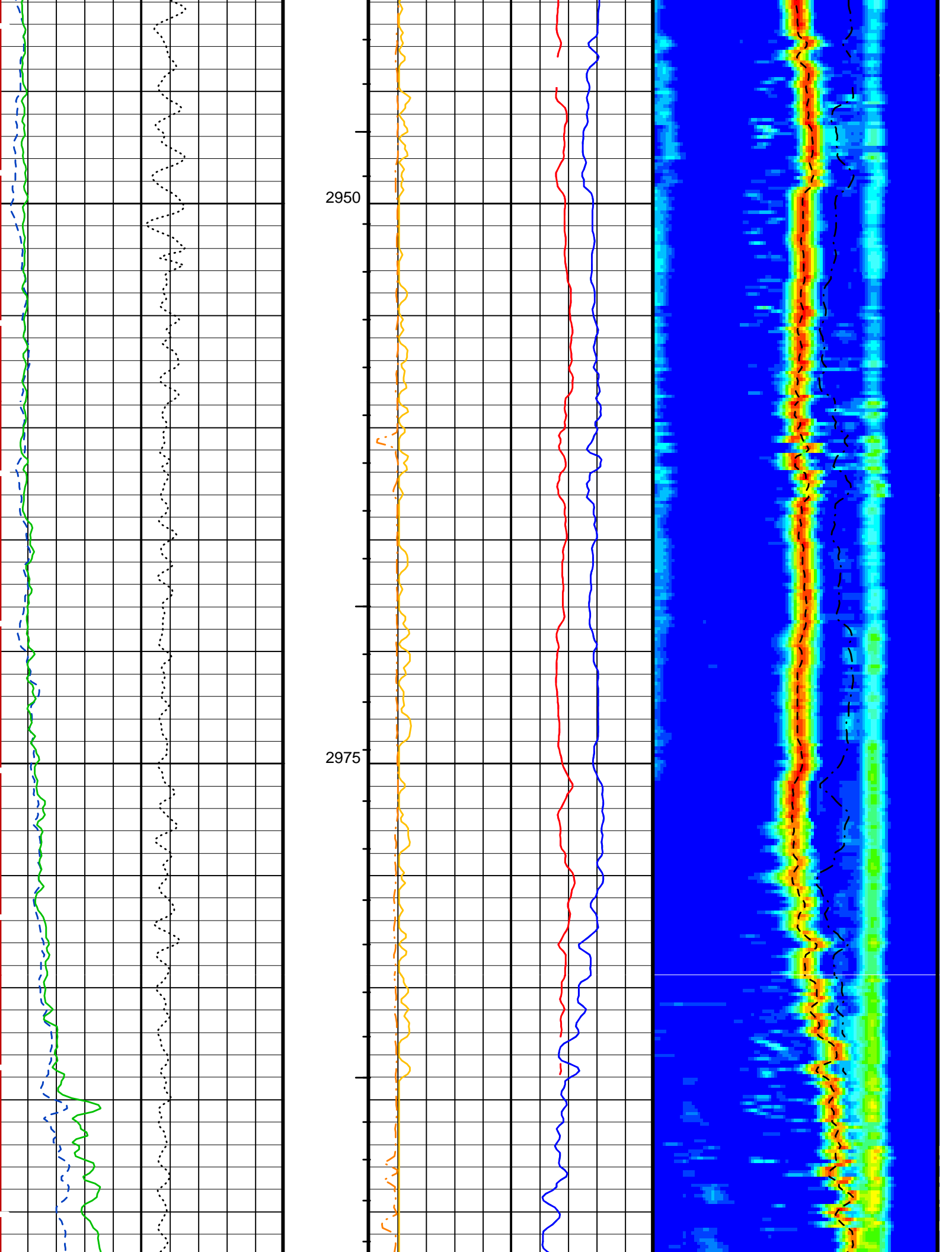

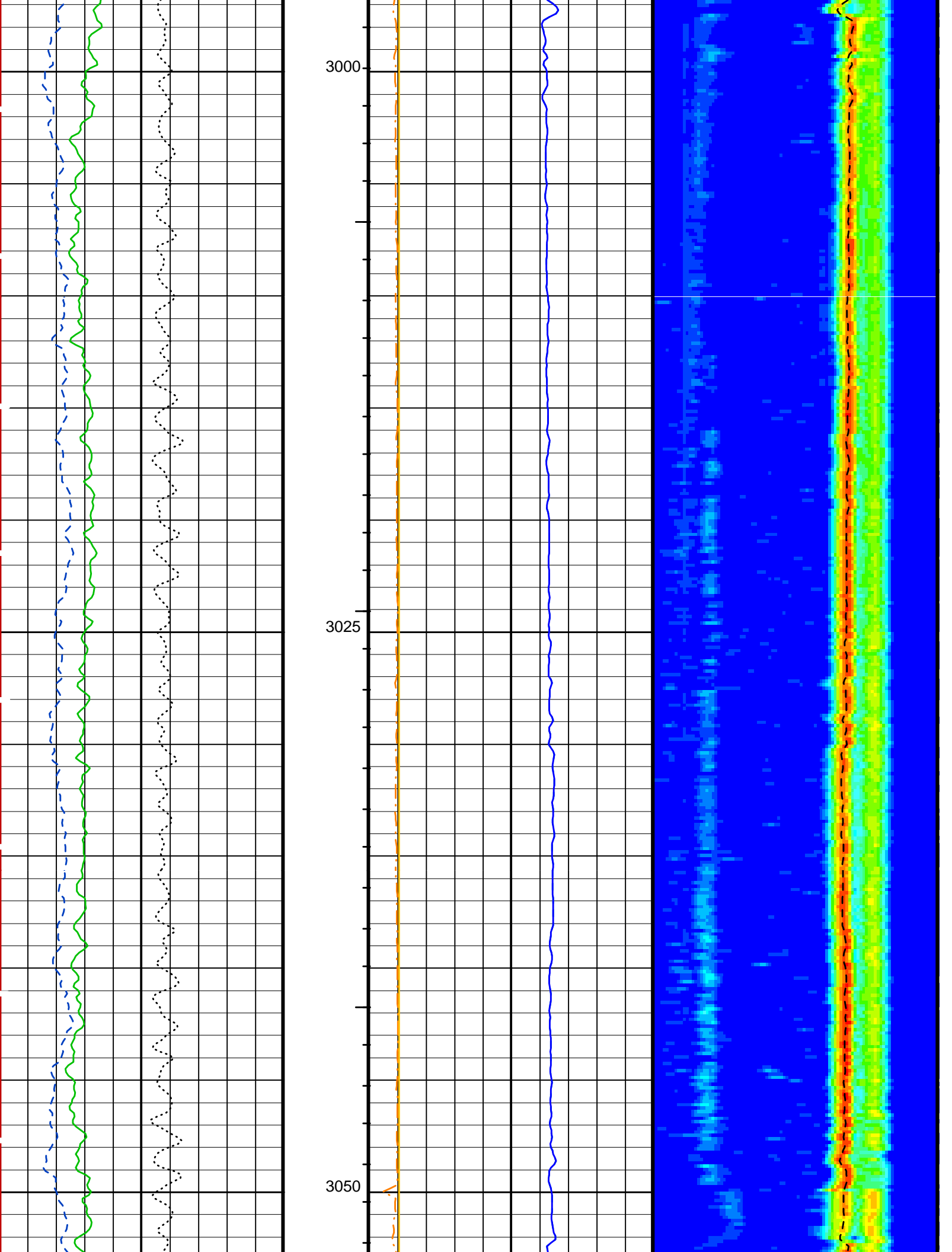

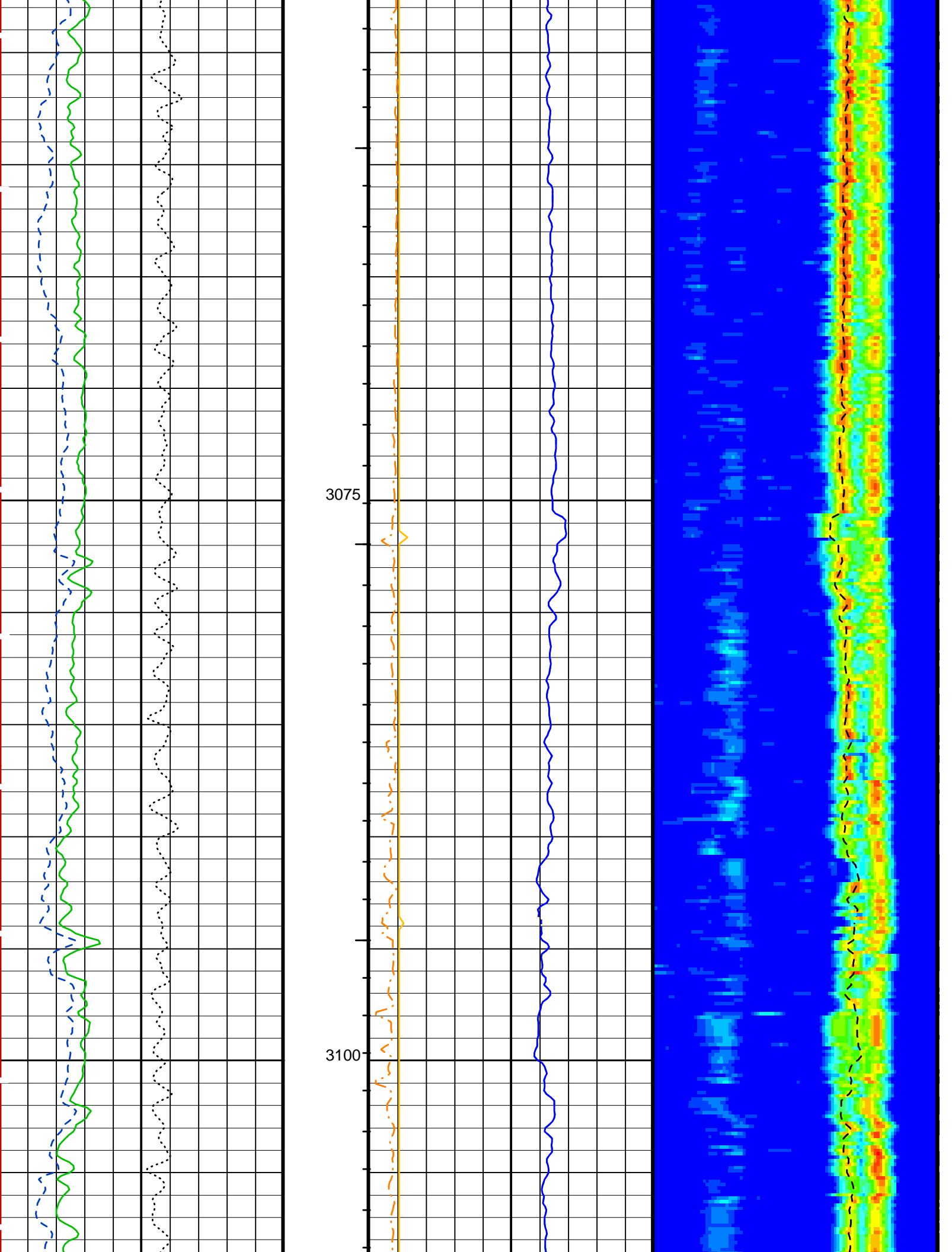

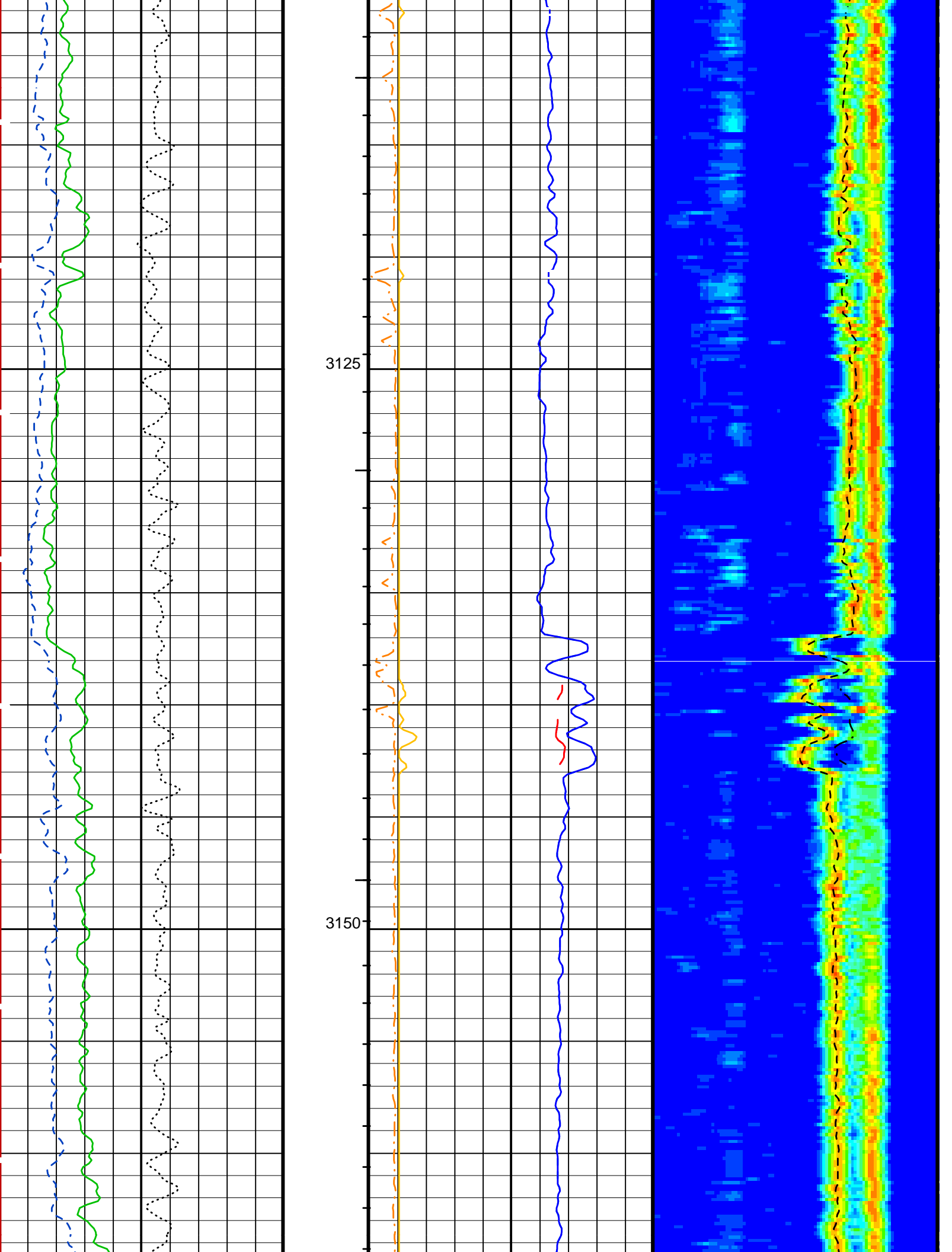

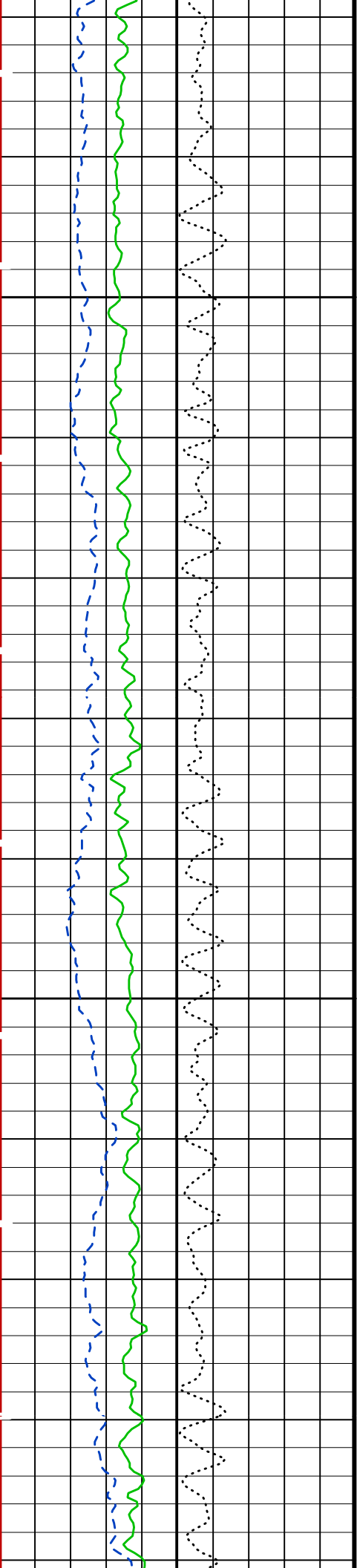

3175

3200

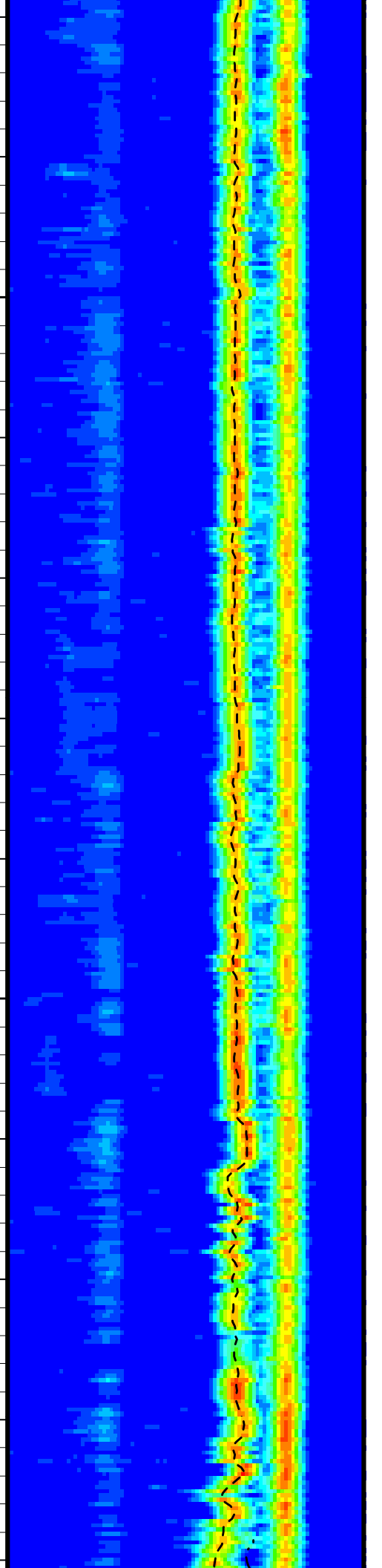
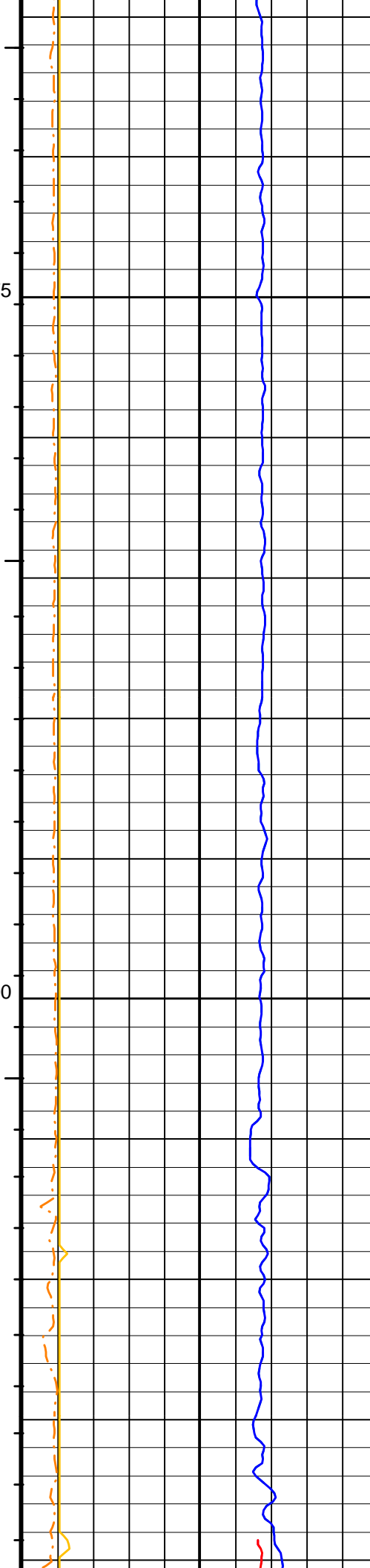

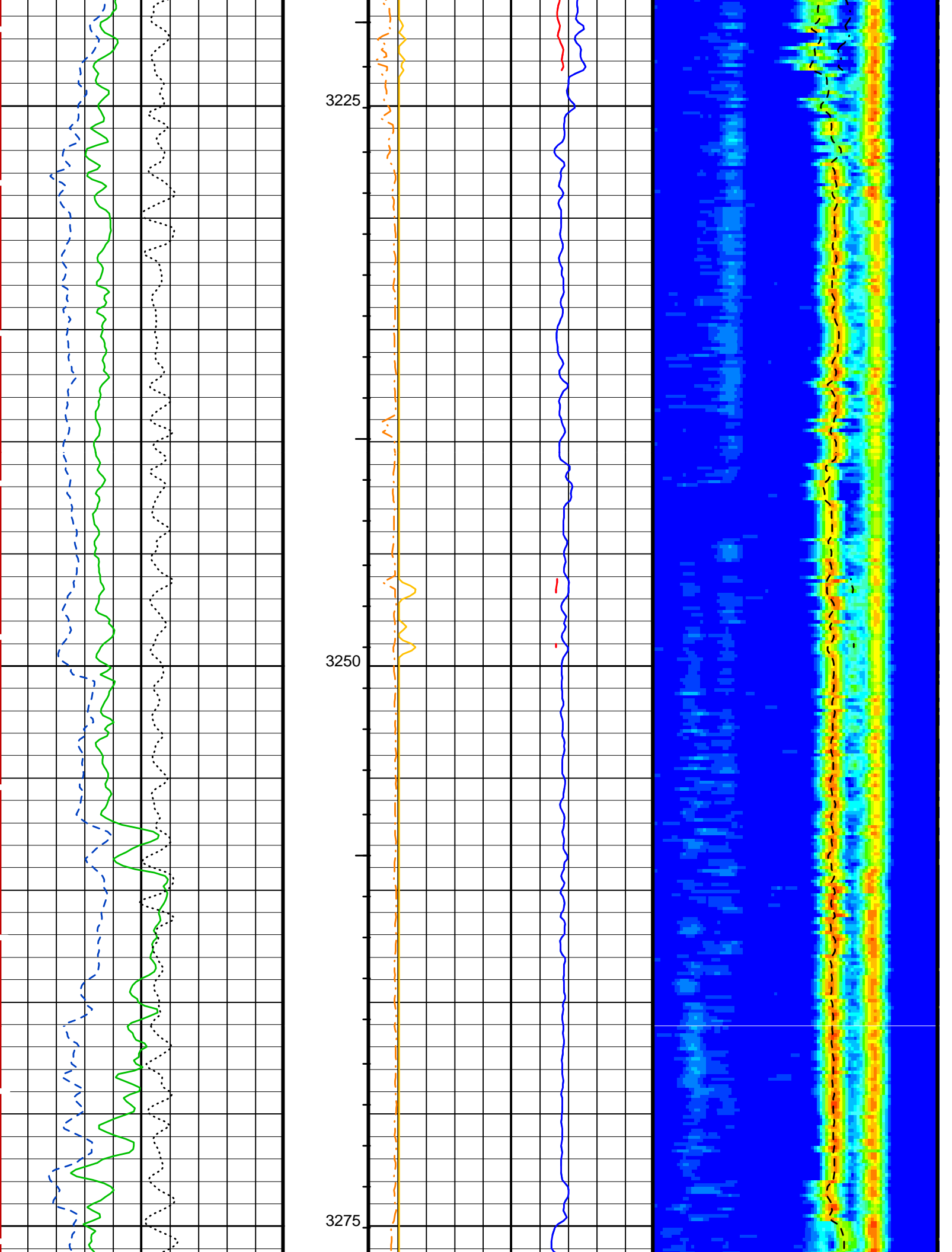

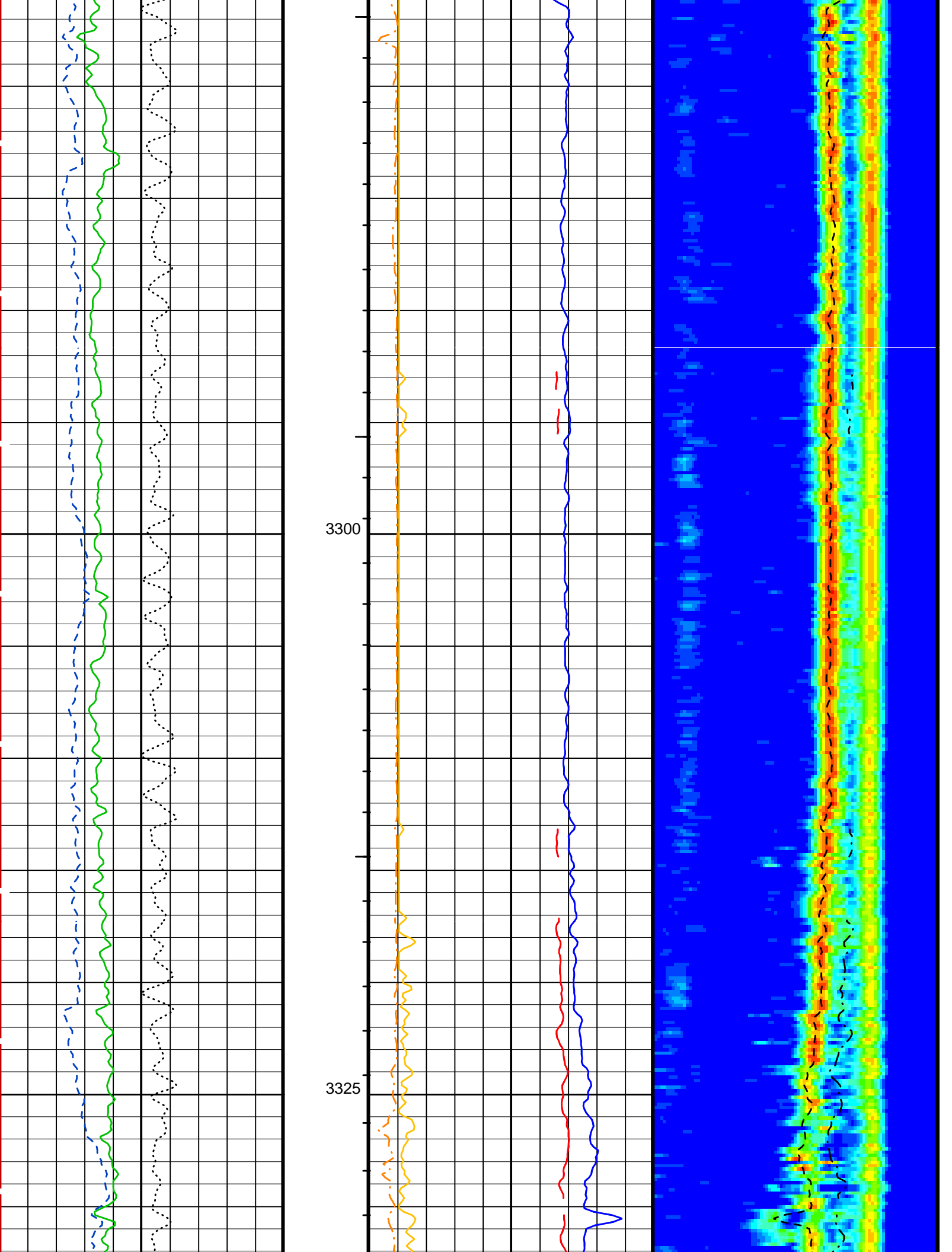

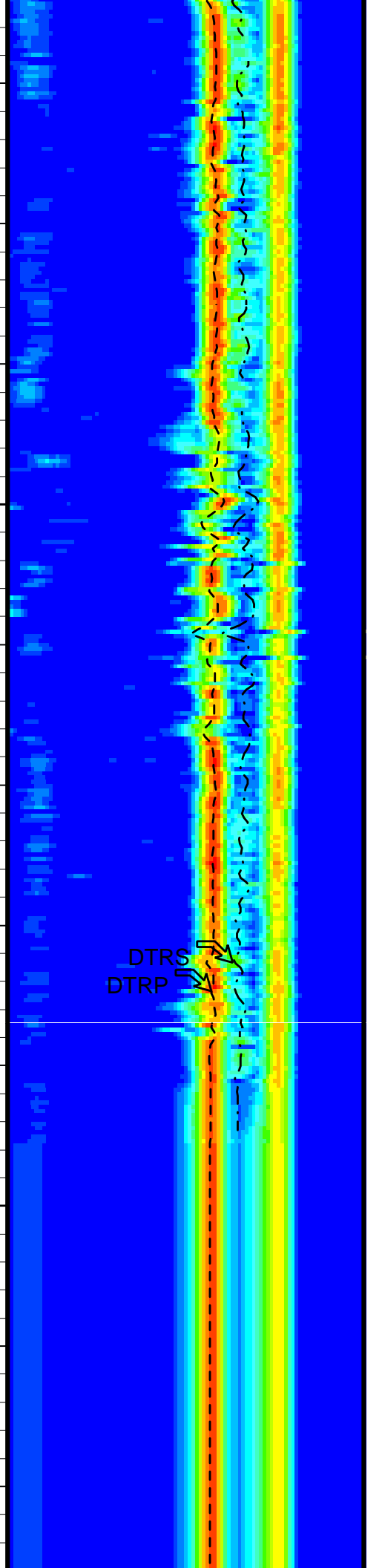
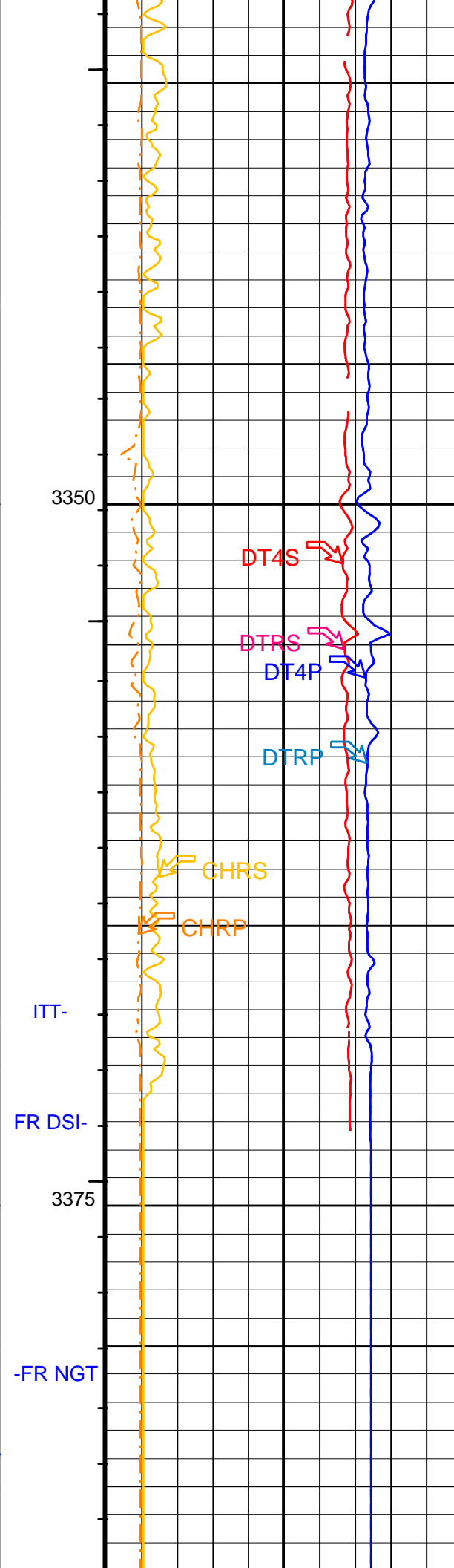
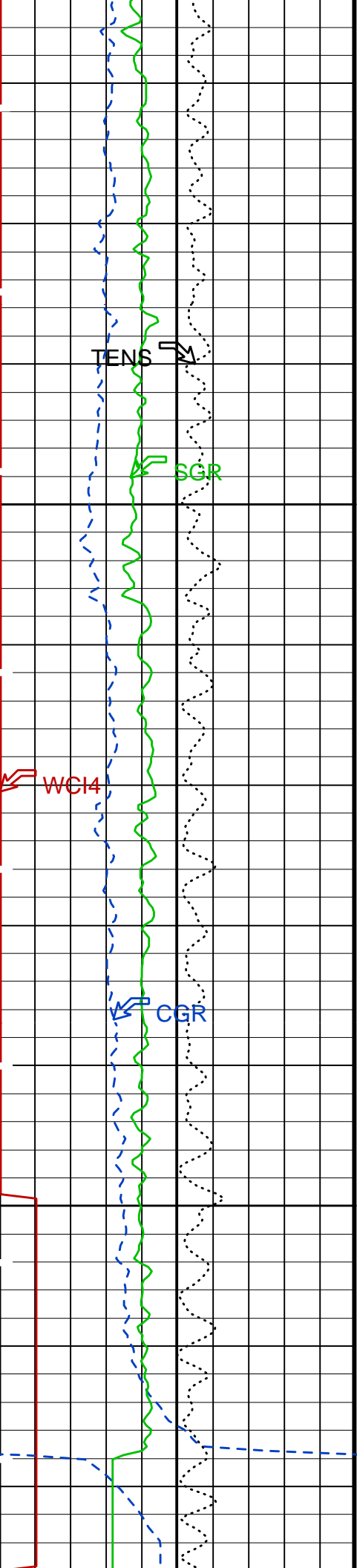

3350

ITT-

FR DSI-

3375

-FR NGT

TENS

SGR

WCI4

CGR

DT4S

DTRS

DT4P

DTRP

CHRS

CHRP

DTRS

DTRP

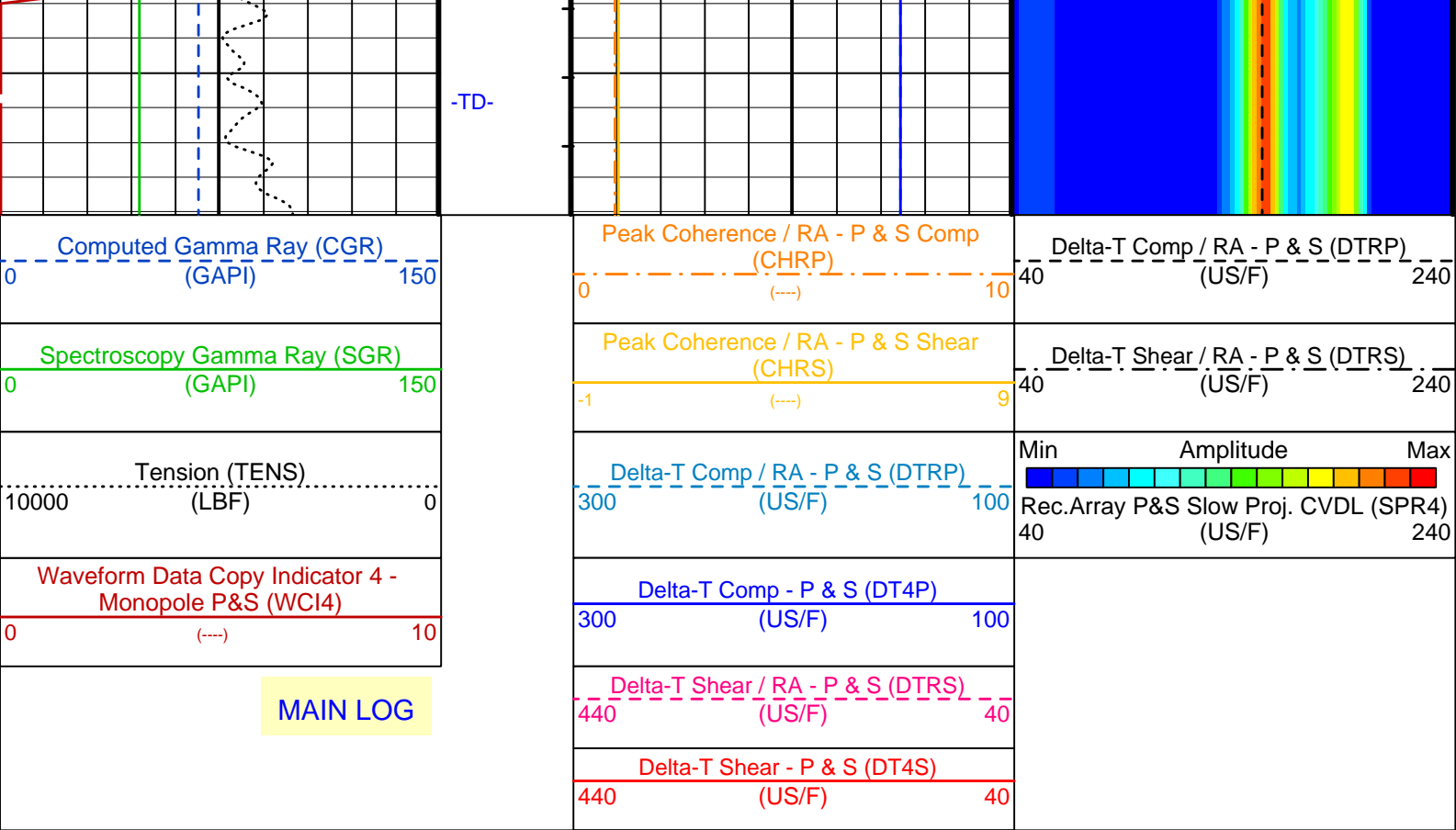

PIP SUMMARY

- └ Integrated Transit Time Minor Pip Every 1 MS
- └ Integrated Transit Time Major Pip Every 10 MS

▶ Time Mark Every 60 S

Parameters

DLIS Name	Description	Value
ALTDPCCHAN	Name of alternate depth channel	SpeedCorrectedDepth
BARS_MTR1	Length for Monopole Transmitter to Receiver 1	2.7432 M
BHS	Borehole Status	OPEN
BHT	Bottom Hole Temperature (used in calculations)	120 DEGF
BILI	Bond Index Level for Zone Isolation	0.8
BS	Bit Size	9.875 IN
BSAL	Borehole Salinity	-50000.00 PPM
CASF	Label Casing Function - Monopole P&S	50
CBAR	Constant Barite	1
CDTS	C-Delta-T Shale	100 US/F
CGMI	Spectro Computed Gamma Ray Minimum	0 GAPI
CGSH	Spectro Computed Gamma Ray Shale	100 GAPI
COLL	Label Slowness Lower Limit - Monopole P&S Compressional	110 US/F
CONTYP	Conveyance Type	Wireline
COUL	Label Slowness Upper Limit - Monopole P&S Compressional	185 US/F
CSIZ	Current Casing Size	0.000 IN
CSTR	Compressive Strength of Cement	0 PSIA
CWEI	Casing Weight	0.00 LB/F
DDE1	Digitizing Delay 1	0 US
DDE2	Digitizing Delay 2	0 US
DDE3	Digitizing Delay 3	0 US
DDE4	Digitizing Delay 4	0 US
DDE5	Digitizing Delay 5	0 US
DDEX	Digitizing Delay X	0 US
DEPREM1	Depth Remark 1	
DEPREM2	Depth Remark 2	
DEPREM3	Depth Remark 3	
DEPREM4	Depth Remark 4	
DEPREM5	Depth Remark 5	
DEPREM6	Depth Remark 6	
DFD	Drilling Fluid Density	8.51 LB/G
DLCS	Label Compressional Source - Dipole Shear	USE
DLHS	Label Hole Diameter Source for SOBS Channel	AUTO
DSHL	Label Slowness Lower Limit - Dipole Shear	75 US/F
DSHU	Label Slowness Upper Limit - Dipole Shear	775 US/F
DSI1	Digitizer Sample Interval 1	40 US
DSI2	Digitizer Sample Interval 2	40 US
DSI3	Digitizer Sample Interval 3	10 US

DSI3	Digitizer Sample Interval 3	40	US
DSI4	Digitizer Sample Interval 4	10	US
DSI5	Digitizer Sample Interval 5	10	US
DSIX	Digitizer Sample Interval X	40	US
DTCS	Compressional Delta-T Source for DTCO Channel	PS_COMP	
DTF	Delta-T Fluid	189	US/F
DTM	Delta-T Matrix	56	US/F
DTSS	Shear Delta-T Source for DTSM Channel	UPPER_DIPOLE	
DWC1	Digitizer Word Count 1	512	
DWC2	Digitizer Word Count 2	512	
DWC3	Digitizer Word Count 3	512	
DWC4	Digitizer Word Count 4	512	
DWC5	Digitizer Word Count 5	512	
DWCX	Digitizer Word Count X	512	
FCF	CBL Fluid Compensation Factor	1	
FGM5	First Motion Gate Moveout 5	40	US/F
FILG	Label Fill Gap Control - Monopole P&S	COMP_SHEAR	
FMG5	First Motion Minimum Gate 5	500	US
FMLL	Slowness Lower Limit - FMD	40	US/F
FMRC	Restart Control - FMD	CONTINUE	
FMT5	First Motion Threshold 5	UP	
FMUL	Slowness Upper Limit - FMD	180	US/F
FPM	Processing Mode - FMD	NONE	
GCSE	Generalized Caliper Selection	BS	
GDEV	Average Angular Deviation of Borehole from Normal	0	DEG
GDT1	Gain Delta-T 1	800	US/F
GDT2	Gain Delta-T 2	800	US/F
GDT3	Gain Delta-T 3	800	US/F
GDT4	Gain Delta-T 4	160	US/F
GDT5	Gain Delta-T 5	160	US/F
GDTX	Gain Delta-T X	800	US/F
GGRD	Geothermal Gradient	0.01	DF/F
GIN1	Gain Interval 1	15360	US
GIN2	Gain Interval 2	15360	US
GIN3	Gain Interval 3	15360	US
GIN4	Gain Interval 4	2560	US
GIN5	Gain Interval 5	1600	US
GINX	Gain Interval X	15360	US
GOBO	Good Bond	2	MV
GRSE	Generalized Mud Resistivity Selection	CHART_GEN_9	
GTSE	Generalized Temperature Selection	LINEAR_ESTIMATE	
IDWCD	IDW Calibration Date (dd-MMM-yyyy)	dd-MMM-yyyy	
IDWCNS	IDW Calibrator Serial Number	-999	
IDWLNC	IDW Calibration Cable Type	7-46P	
IDWSN	IDW Serial Number	-999	
IDWTYP	IDW Type	IDW-B	
IDWWC1	IDW Wheel Correction 1	-999	
IDWWC2	IDW Wheel Correction 2	-999	
ITTS	Integrated Transit Time Source	DTCO	
KMIN	Potassium Minimum	0	
KSHA	Potassium Shale	0.02	
LCSN	Logging Cable Serial Number	-999	
LFC	Label Formation Character - Monopole P&S	DYNAMIC	
LOGSEQ	Log Sequence	First_Log_In_Well	
LTXG	Lower Dipole Transmitter Geometry	156	IN
MAGR	Reference Earth Magnetic Field	62458	MTES
MAI5	Slowness Averaging Interval - FMD	42	IN
MATR	Rock Matrix for Neutron Porosity Corrections	LIMESTONE	
MCI	Minimum Cemented Interval	10	FT
MCS	Mean Casing Slowness	57	US/F
MDS5	Multishot Delta-T Scatter - FMD	20	US
MSA	Minimum Sonic Amplitude	0	MV
MSL	Mode Slow Loop	CLOSE	
MST	Mud Sample Temperature	58.00	DEGF
MTXG	Monopole Transmitter Geometry	186	IN
NFO	NGT Filtering Option	KALMAN	
NMBI	NMr sensor Bias	62458	MTES
NWS1	Number Waveforms Stacked 1	2	
NWS2	Number Waveforms Stacked 2	2	
NWS3	Number Waveforms Stacked 3	1	
NWS4	Number Waveforms Stacked 4	4	
NWS5	Number Waveforms Stacked 5	1	
NWSX	Number Waveforms Stacked X	1	
PBVSADP	Use alternate depth channel for playback	NO	
PCSL	Programmable Correction Slow Loop	83.6745	KEV
PMUD	Potassium Mud	0	%
RATE	Firing Rate	R7	
RIGTYP	Rig Type	Offshore_Floater_with_WMC	
RLDT	Reference Log Date (dd-MMM-yyyy)	dd-MMM-yyyy	
RLNM	Reference Log Name		
RLRN	Reference Log Run Number		
RMFS	Resistivity of Mud Filtrate Sample	-50000.0000	OHMM
RSMN	Label Shear/Compressional Minimum Ratio - Monopole P&S	1.1	
RSMX	Label Shear/Compressional Maximum Ratio - Monopole P&S	2.12	
RULB	Rig Up Length at Bottom	0	FT

RULS	Rig Up Length at Surface	0	FT
RW	Resistivity of Connate Water	1.0000	OHMM
RX1G	Receiver 1 Geometry	294	IN
RX2G	Receiver 2 Geometry	300	IN
RX3G	Receiver 3 Geometry	306	IN
RX4G	Receiver 4 Geometry	312	IN
RX5G	Receiver 5 Geometry	318	IN
RX6G	Receiver 6 Geometry	324	IN
RX7G	Receiver 7 Geometry	330	IN
RX8G	Receiver 8 Geometry	336	IN
SAM1	DSST Sonic Acquisition Mode 1 - Lower Dipole Mode	LFD_EVEN	
SAM2	DSST Sonic Acquisition Mode 2 - Upper Dipole Mode	ODD	
SAM3	DSST Sonic Acquisition Mode 3 - Low Frequency Monopole Mode for Stoneley	OFF	
SAM4	DSST Sonic Acquisition Mode 4 - High Frequency Monopole Mode for P&S	EVEN	
SAM5	DSST Sonic Acquisition Mode 5 - High Frequency Monopole Mode for FMD	OFF	
SAMX	DSST Sonic Acquisition Mode X - Both Dipoles or Monopole Mode for Expert	OFF	
SAS1	STC Sonic Array Status - Lower Dipole	255	
SAS2	STC Sonic Array Status - Upper Dipole	255	
SAS3	STC Sonic Array Status - Monopole Stoneley	255	
SAS4	STC Sonic Array Status - Monopole P&S	255	
SAS5	Sonic Array Status - FMD	255	
SBO1	STC Search Band Offset - Lower Dipole	3000	US
SBO2	STC Search Band Offset - Upper Dipole	3000	US
SBO3	STC Search Band Offset - Monopole Stoneley	3000	US
SBO4	STC Search Band Offset - Monopole P&S	500	US
SBR4	STC Baseline Removal - Monopole P&S	ON	
SBW1	STC Search Bandwidth - Lower Dipole	8000	US
SBW2	STC Search Bandwidth - Upper Dipole	8000	US
SBW3	STC Search Bandwidth - Monopole Stoneley	8000	US
SBW4	STC Search Bandwidth - Monopole P&S	2000	US
SCORR	Stretch Correction	-50000	FT
SFC1	STC Formation Character - Lower Dipole	SELECTABLE	
SFC2	STC Formation Character - Upper Dipole	SELECTABLE	
SFC3	STC Formation Character - Monopole Stoneley	SELECTABLE	
SFC4	STC Formation Character - Monopole P&S	SELECTABLE	
SFM1	STC Filter - Lower Dipole	B.3-1.5K	
SFM2	STC Filter - Upper Dipole	B1-3K	
SFM3	STC Filter - Monopole Stoneley	B.5-1.5K	
SFM4	STC Filter - Monopole P&S	B3-20K	
SGMI	Spectro Gamma Ray Minimum	0	GAPI
SGSH	Spectro Gamma Ray Shale	100	GAPI
SHLL	Label Slowness Lower Limit - Monopole P&S Shear	75	US/F
SHT	Surface Hole Temperature	68	DEGF
SHUL	Label Slowness Upper Limit - Monopole P&S Shear	180	US/F
SLL1	STC Slowness Lower Limit - Lower Dipole	75	US/F
SLL2	STC Slowness Lower Limit - Upper Dipole	75	US/F
SLL3	STC Slowness Lower Limit - Monopole Stoneley	180	US/F
SLL4	STC Slowness Lower Limit - Monopole P&S	40	US/F
SPFS	Sonic Porosity Formula	RAYMER_HUNT	
SPSO	Sonic Porosity Source	DTCO	
SST1	STC Slowness Step - Lower Dipole	4	US/F
SST2	STC Slowness Step - Upper Dipole	4	US/F
SST3	STC Slowness Step - Monopole Stoneley	4	US/F
SST4	STC Slowness Step - Monopole P&S	2	US/F
SSW1	STC Source Waveform - Lower Dipole	WF_SAM1	
SSW2	STC Source Waveform - Upper Dipole	WF_SAM2	
STDLC	Subsequent Trip Down Log Correction	-50000	FT
STLL	Label Slowness Lower Limit - Monopole Stoneley	180	US/F
STUL	Label Slowness Upper Limit - Monopole Stoneley	780	US/F
SUL1	STC Slowness Upper Limit - Lower Dipole	775	US/F
SUL2	STC Slowness Upper Limit - Upper Dipole	775	US/F
SUL3	STC Slowness Upper Limit - Monopole Stoneley	780	US/F
SUL4	STC Slowness Upper Limit - Monopole P&S	240	US/F
SUOR	Susceptibility Operating Range	NORM	
SWD1	STC Slowness Width - Lower Dipole	40	US/F
SWD2	STC Slowness Width - Upper Dipole	40	US/F
SWD3	STC Slowness Width - Monopole Stoneley	40	US/F
SWD4	STC Slowness Width - Monopole P&S	10	US/F
TBF1	STC Time for Baseline Fill - Lower Dipole	0	US
TBF2	STC Time for Baseline Fill - Upper Dipole	0	US
TBF3	STC Time for Baseline Fill - Monopole Stoneley	0	US
TBF4	STC Time for Baseline Fill - Monopole P&S	300	US
TD	Total Depth	11470	FT
TDD	Total Depth - Driller	11154.00	FT
TDL	Total Depth - Logger	11154.00	FT
TLL1	STC Time Lower Limit - Lower Dipole	600	US
TLL2	STC Time Lower Limit - Upper Dipole	600	US
TLL3	STC Time Lower Limit - Monopole Stoneley	600	US
TLL4	STC Time Lower Limit - Monopole P&S	150	US
TMIN	Thorium Minimum	0	PPM
TNDCD	Tension Device Calibration Date (dd-MMM-yyy)	dd-MMM-yyy	

TNDCCD	Tension Device Calibration Date (dd-mm-yy)	dd-mm-yy	
TNDCSN	Tension Device Calibrator Serial Number	-999	
TNDGN	Tension Device GAIN	1	
TNDOFF	Tension Device Offset	0	
TNDSN	Tension Device Serial Number	-999	
TNDTYP	Tension Device	CMTD-B/A	
TSHA	Thorium Shale	12	PPM
TST1	STC Time Step - Lower Dipole	200	US
TST2	STC Time Step - Upper Dipole	200	US
TST3	STC Time Step - Monopole Stoneley	200	US
TST4	STC Time Step - Monopole P&S	50	US
TUL1	STC Time Upper Limit - Lower Dipole	15912.5	US
TUL2	STC Time Upper Limit - Upper Dipole	15525	US
TUL3	STC Time Upper Limit - Monopole Stoneley	12000	US
TUL4	STC Time Upper Limit - Monopole P&S	3660	US
TWD1	STC Time Width - Lower Dipole	2000	US
TWD2	STC Time Width - Upper Dipole	2000	US
TWD3	STC Time Width - Monopole Stoneley	2000	US
TWD4	STC Time Width - Monopole P&S	1000	US
TWI1	STC Integration Time Window - Lower Dipole	1600	US
TWI2	STC Integration Time Window - Upper Dipole	1600	US
TWI3	STC Integration Time Window - Monopole Stoneley	2400	US
TWI4	STC Integration Time Window - Monopole P&S	500	US
TWRX	Transmitter Waveform Sample Rate X	5	US
TWS	Temperature of Connate Water Sample	100.00	DEGF
TWSX	Transmitter Waveform Select X	0	
UMIN	Uranium Minimum	0	PPM
USHA	Uranium Shale	3	PPM
UTXG	Upper Dipole Transmitter Geometry	162	IN
WFM1	Waveform Mode 1	W1	
WFM2	Waveform Mode 2	W1	
WFM3	Waveform Mode 3	W1	
WFM4	Waveform Mode 4	W1	
WFM5	Waveform Mode 5	W1	
WFMX	Waveform Mode X	W1	
ZRCS	Tool Zero Reference Check at Surface	-50000	FT

Format: DSST_P_S_VDL_COLOR Vertical Scale: 1:200 Graphics File Created: 03-May-2000 02:29

OP System Version: 9C1-303			
MCM			
GHMT-A	9C1-303	NGT-C	9C1-303
DTA-A	9C1-303	DSST-B	9C1-303
DTC-H	9C1-303		

Output DLIS Files			
DEFAULT	GHMT .018	FN:29 PRODUCER	03-May-2000 02:29
GHMT_CUST	GHMT .018	FN:30 PRODUCER	03-May-2000 02:29

Output DLIS Files					
DEFAULT	GHMT .020	FN:33 PRODUCER	03-May-2000 05:14	3010.1 M	2889.5 M
GHMT_CUST	GHMT .020	FN:34 PRODUCER	03-May-2000 05:14	3010.1 M	2889.5 M

OP System Version: 9C1-303			
MCM			
GHMT-A	9C1-303	NGT-C	9C1-303
DTA-A	9C1-303	DSST-B	9C1-303
DTC-H	9C1-303		

PIP SUMMARY

↓ Integrated Transit Time Minor Pip Every 1 MS
 ← Integrated Transit Time Major Pip Every 10 MS

Time Mark Every 60 S

REPEAT SECTION	Delta-T Shear - P & S (DT4S)	440 (US/F) 40
	Delta-T Shear / RA - P & S (DTRS)	440 (US/F) 40
	Delta-T Comp - P & S (DT4P)	300 (US/F) 100
Waveform Data Copy Indicator 4 - Monopole P&S (WCI4)		
0 (ms) 10		

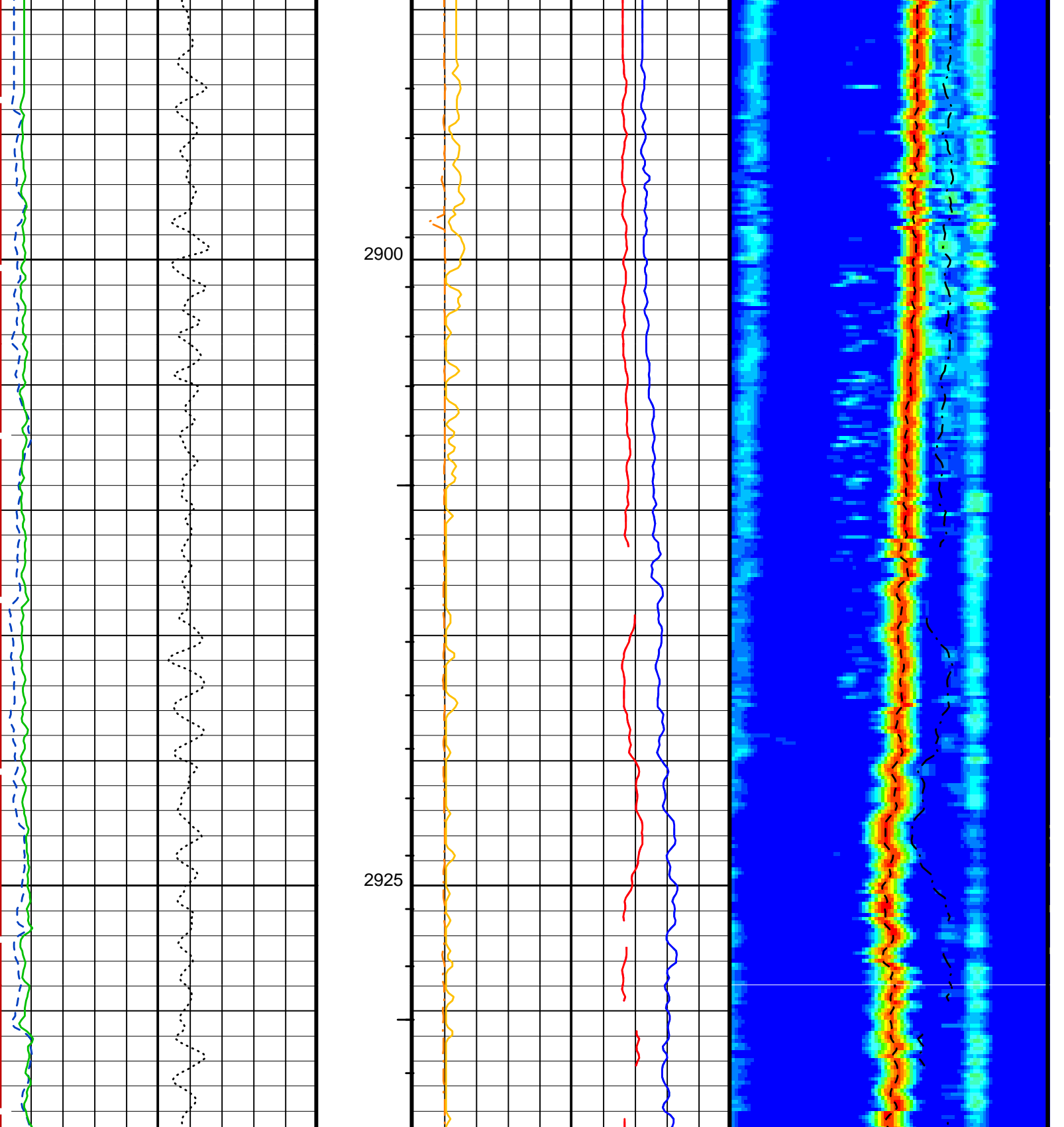
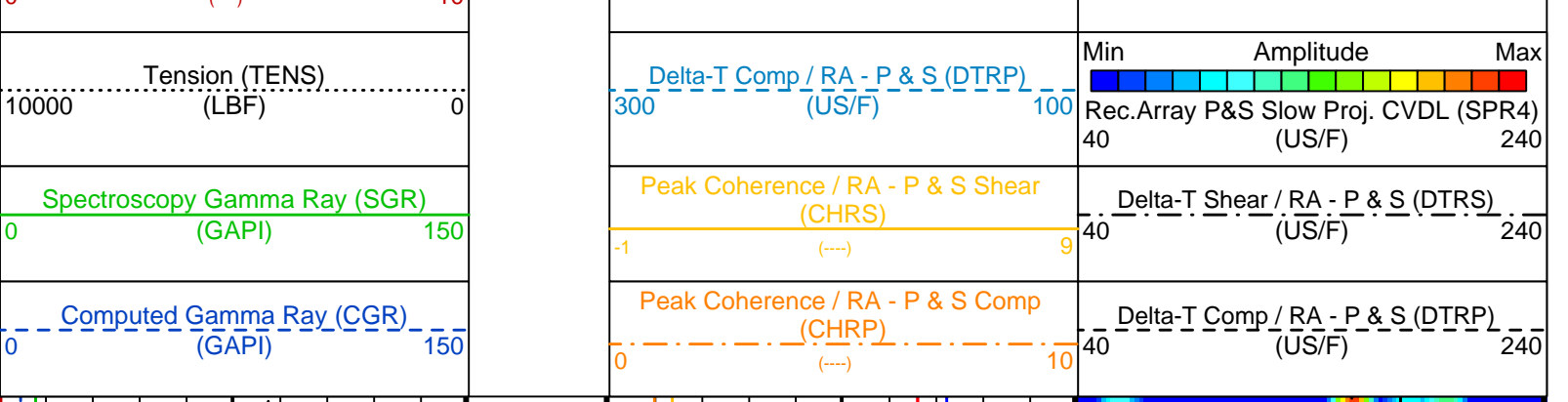

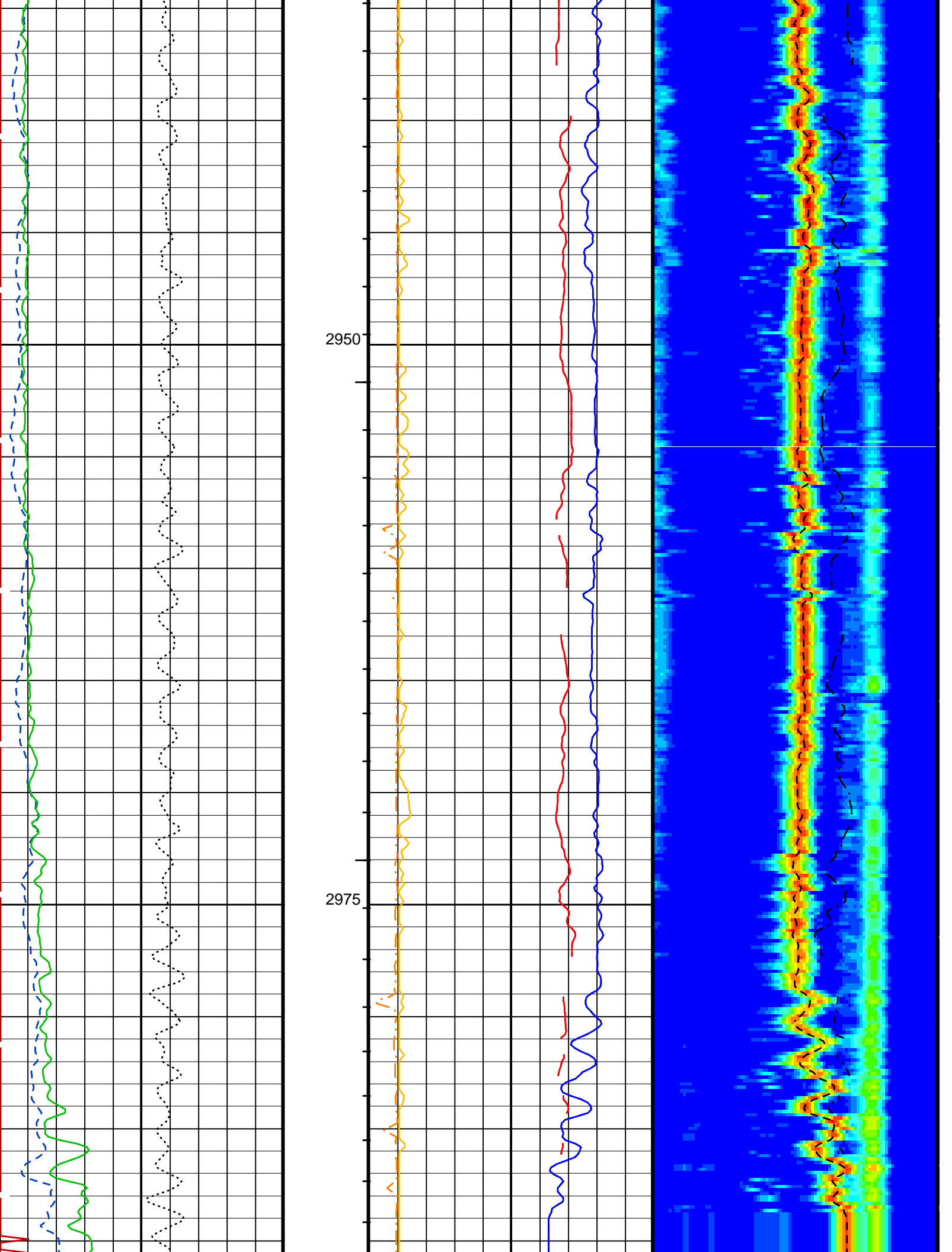

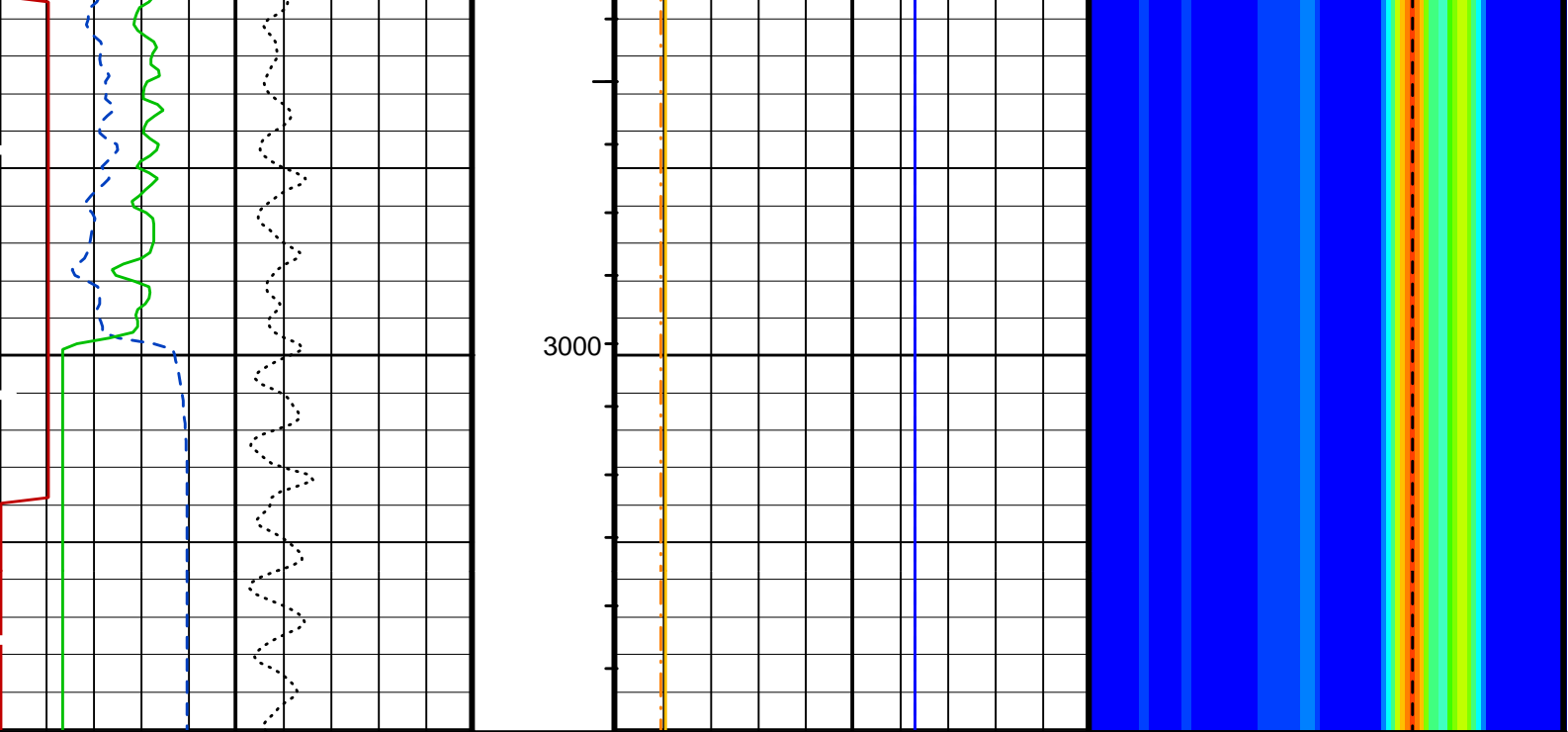

<p>Computed Gamma Ray (CGR) (GAPI)</p> <p>Spectroscopy Gamma Ray (SGR) (GAPI)</p> <p>Tension (TENS) (LBF)</p> <p>Waveform Data Copy Indicator 4 - Monopole P&S (WCI4)</p>	<p>Peak Coherence / RA - P & S Comp (CHRP)</p> <p>Peak Coherence / RA - P & S Shear (CHRS)</p> <p>Delta-T Comp / RA - P & S (DTRP) (US/F)</p> <p>Delta-T Comp - P & S (DT4P) (US/F)</p> <p>Delta-T Shear / RA - P & S (DTRS) (US/F)</p> <p>Delta-T Shear - P & S (DT4S) (US/F)</p>	<p>Delta-T Comp / RA - P & S (DTRP) (US/F)</p> <p>Delta-T Shear / RA - P & S (DTRS) (US/F)</p> <p>Min Amplitude Max Rec.Array P&S Slow Proj. CVDL (SPR4) (US/F)</p>
<p>REPEAT SECTION</p>		

PIP SUMMARY

- ┆ Integrated Transit Time Minor Pip Every 1 MS
- ┆ Integrated Transit Time Major Pip Every 10 MS

Time Mark Every 60 S

Parameters

DLIS Name	Description	Value
ALTDPCAN	Name of alternate depth channel	SpeedCorrectedDepth
BARS_MTR1	Length for Monopole Transmitter to Receiver 1	2.7432 M
BHS	Borehole Status	OPEN
BHT	Bottom Hole Temperature (used in calculations)	120 DEG F
BILI	Bond Index Level for Zone Isolation	0.8
BS	Bit Size	9.875 IN
BSAL	Borehole Salinity	-50000.00 PPM
CASF	Label Casing Function - Monopole P&S	50
CBAR	Constant Barite	1
CDTS	C-Delta-T Shale	100 US/F
CGMI	Spectro Computed Gamma Ray Minimum	0 GAPI
CGSH	Spectro Computed Gamma Ray Shale	100 GAPI
COLL	Label Slowness Lower Limit - Monopole P&S Compressional	110 US/F
CONTYP	Conveyance Type	Wireline
COUL	Label Slowness Upper Limit - Monopole P&S Compressional	185 US/F
CSIZ	Current Casing Size	0.000 IN
CSTR	Compressive Strength of Cement	0 PSIA

CWEI	Casing Weight	0.00	LB/F
DDE1	Digitizing Delay 1	0	US
DDE2	Digitizing Delay 2	0	US
DDE3	Digitizing Delay 3	0	US
DDE4	Digitizing Delay 4	0	US
DDE5	Digitizing Delay 5	0	US
DDEX	Digitizing Delay X	0	US
DEPREM1	Depth Remark 1		
DEPREM2	Depth Remark 2		
DEPREM3	Depth Remark 3		
DEPREM4	Depth Remark 4		
DEPREM5	Depth Remark 5		
DEPREM6	Depth Remark 6		
DFD	Drilling Fluid Density	8.51	LB/G
DLCS	Label Compressional Source - Dipole Shear	USE	
DLHS	Label Hole Diameter Source for SOBS Channel	AUTO	
DSHL	Label Slowness Lower Limit - Dipole Shear	75	US/F
DSHU	Label Slowness Upper Limit - Dipole Shear	775	US/F
DSI1	Digitizer Sample Interval 1	40	US
DSI2	Digitizer Sample Interval 2	40	US
DSI3	Digitizer Sample Interval 3	40	US
DSI4	Digitizer Sample Interval 4	10	US
DSI5	Digitizer Sample Interval 5	10	US
DSIX	Digitizer Sample Interval X	40	US
DTCS	Compressional Delta-T Source for DTCO Channel	PS_COMP	
DTF	Delta-T Fluid	189	US/F
DTM	Delta-T Matrix	56	US/F
DTSS	Shear Delta-T Source for DTSM Channel	UPPER_DIPOLE	
DWC1	Digitizer Word Count 1	512	
DWC2	Digitizer Word Count 2	512	
DWC3	Digitizer Word Count 3	512	
DWC4	Digitizer Word Count 4	512	
DWC5	Digitizer Word Count 5	512	
DWCX	Digitizer Word Count X	512	
FCF	CBL Fluid Compensation Factor	1	
FGM5	First Motion Gate Moveout 5	40	US/F
FILG	Label Fill Gap Control - Monopole P&S	COMP_SHEAR	
FMG5	First Motion Minimum Gate 5	500	US
FMLL	Slowness Lower Limit - FMD	40	US/F
FMRC	Restart Control - FMD	CONTINUE	
FMT5	First Motion Threshold 5	UP	
FMUL	Slowness Upper Limit - FMD	180	US/F
FPM	Processing Mode - FMD	NONE	
GCSE	Generalized Caliper Selection	BS	
GDEV	Average Angular Deviation of Borehole from Normal	0	DEG
GDT1	Gain Delta-T 1	800	US/F
GDT2	Gain Delta-T 2	800	US/F
GDT3	Gain Delta-T 3	800	US/F
GDT4	Gain Delta-T 4	160	US/F
GDT5	Gain Delta-T 5	160	US/F
GDTX	Gain Delta-T X	800	US/F
GGRD	Geothermal Gradient	0.01	DF/F
GIN1	Gain Interval 1	15360	US
GIN2	Gain Interval 2	15360	US
GIN3	Gain Interval 3	15360	US
GIN4	Gain Interval 4	2560	US
GIN5	Gain Interval 5	1600	US
GINX	Gain Interval X	15360	US
GOBO	Good Bond	2	MV
GRSE	Generalized Mud Resistivity Selection	CHART_GEN_9	
GTSE	Generalized Temperature Selection	LINEAR_ESTIMATE	
IDWCD	IDW Calibration Date (dd-MMM-yyyy)	dd-MMM-yyyy	
IDWCSN	IDW Calibrator Serial Number	-999	
IDWLCCN	IDW Calibration Cable Type	7-46P	
IDWSN	IDW Serial Number	-999	
IDWTYP	IDW Type	IDW-B	
IDWWC1	IDW Wheel Correction 1	-999	
IDWWC2	IDW Wheel Correction 2	-999	
ITTS	Integrated Transit Time Source	DTCO	
KMIN	Potassium Minimum	0	
KSHA	Potassium Shale	0.02	
LCSN	Logging Cable Serial Number	-999	
LFC	Label Formation Character - Monopole P&S	DYNAMIC	
LOGSEQ	Log Sequence	First_Log_In_Well	
LTXG	Lower Dipole Transmitter Geometry	156	IN
MAGR	Reference Earth Magnetic Field	62458	MTES
MAI5	Slowness Averaging Interval - FMD	42	IN
MATR	Rock Matrix for Neutron Porosity Corrections	LIMESTONE	
MCI	Minimum Cemented Interval	10	FT
MCS	Mean Casing Slowness	57	US/F
MDS5	Multishot Delta-T Scatter - FMD	20	US
MSA	Minimum Sonic Amplitude	0	MV
MSL	Mode Slow Loop	CLOSE	
MST	Mud Sample Temperature	58.00	DEGF
MTXG	Monopole Transmitter Geometry	186	IN

NFO	Number Waveforms Stacked 1		
NMBI	NMn sensor Bias	62458	MTES
NWS1	Number Waveforms Stacked 2	2	
NWS2	Number Waveforms Stacked 2	2	
NWS3	Number Waveforms Stacked 3	1	
NWS4	Number Waveforms Stacked 4	4	
NWS5	Number Waveforms Stacked 5	1	
NWSX	Number Waveforms Stacked X	1	
PBVSADP	Use alternate depth channel for playback	NO	
PCSL	Programmable Correction Slow Loop	83.6745	KEV
PMUD	Potassium Mud	0	%
RATE	Firing Rate	R7	
RIGTYP	Rig Type	Offshore_Floater_with_WMC	
RLDT	Reference Log Date (dd-MMM-yyyy)	dd-MMM-yyyy	
RLNM	Reference Log Name		
RLRN	Reference Log Run Number		
RMFS	Resistivity of Mud Filtrate Sample	-50000.0000	OHMM
RSMN	Label Shear/Compressional Minimum Ratio - Monopole P&S	1.1	
RSMX	Label Shear/Compressional Maximum Ratio - Monopole P&S	2.12	
RULB	Rig Up Length at Bottom	0	FT
RULS	Rig Up Length at Surface	0	FT
RW	Resistivity of Connate Water	1.0000	OHMM
RX1G	Receiver 1 Geometry	294	IN
RX2G	Receiver 2 Geometry	300	IN
RX3G	Receiver 3 Geometry	306	IN
RX4G	Receiver 4 Geometry	312	IN
RX5G	Receiver 5 Geometry	318	IN
RX6G	Receiver 6 Geometry	324	IN
RX7G	Receiver 7 Geometry	330	IN
RX8G	Receiver 8 Geometry	336	IN
SAM1	DSST Sonic Acquisition Mode 1 - Lower Dipole Mode	LFD_EVEN	
SAM2	DSST Sonic Acquisition Mode 2 - Upper Dipole Mode	ODD	
SAM3	DSST Sonic Acquisition Mode 3 - Low Frequency Monopole Mode for Stoneley	OFF	
SAM4	DSST Sonic Acquisition Mode 4 - High Frequency Monopole Mode for P&S	EVEN	
SAM5	DSST Sonic Acquisition Mode 5 - High Frequency Monopole Mode for FMD	OFF	
SAMX	DSST Sonic Acquisition Mode X - Both Dipoles or Monopole Mode for Expert	OFF	
SAS1	STC Sonic Array Status - Lower Dipole	255	
SAS2	STC Sonic Array Status - Upper Dipole	255	
SAS3	STC Sonic Array Status - Monopole Stoneley	255	
SAS4	STC Sonic Array Status - Monopole P&S	255	
SAS5	Sonic Array Status - FMD	255	
SBO1	STC Search Band Offset - Lower Dipole	3000	US
SBO2	STC Search Band Offset - Upper Dipole	3000	US
SBO3	STC Search Band Offset - Monopole Stoneley	3000	US
SBO4	STC Search Band Offset - Monopole P&S	500	US
SBR4	STC Baseline Removal - Monopole P&S	ON	
SBW1	STC Search Bandwidth - Lower Dipole	8000	US
SBW2	STC Search Bandwidth - Upper Dipole	8000	US
SBW3	STC Search Bandwidth - Monopole Stoneley	8000	US
SBW4	STC Search Bandwidth - Monopole P&S	2000	US
SCORR	Stretch Correction	-50000	FT
SFC1	STC Formation Character - Lower Dipole	SELECTABLE	
SFC2	STC Formation Character - Upper Dipole	SELECTABLE	
SFC3	STC Formation Character - Monopole Stoneley	SELECTABLE	
SFC4	STC Formation Character - Monopole P&S	SELECTABLE	
SFM1	STC Filter - Lower Dipole	B.3-1.5K	
SFM2	STC Filter - Upper Dipole	B1-3K	
SFM3	STC Filter - Monopole Stoneley	B.5-1.5K	
SFM4	STC Filter - Monopole P&S	B3-20K	
SGMI	Spectro Gamma Ray Minimum	0	GAPI
SGSH	Spectro Gamma Ray Shale	100	GAPI
SHLL	Label Slowness Lower Limit - Monopole P&S Shear	75	US/F
SHT	Surface Hole Temperature	68	DEGF
SHUL	Label Slowness Upper Limit - Monopole P&S Shear	180	US/F
SLL1	STC Slowness Lower Limit - Lower Dipole	75	US/F
SLL2	STC Slowness Lower Limit - Upper Dipole	75	US/F
SLL3	STC Slowness Lower Limit - Monopole Stoneley	180	US/F
SLL4	STC Slowness Lower Limit - Monopole P&S	40	US/F
SPFS	Sonic Porosity Formula	RAYMER_HUNT	
SPSO	Sonic Porosity Source	DTCO	
SST1	STC Slowness Step - Lower Dipole	4	US/F
SST2	STC Slowness Step - Upper Dipole	4	US/F
SST3	STC Slowness Step - Monopole Stoneley	4	US/F
SST4	STC Slowness Step - Monopole P&S	2	US/F
SSW1	STC Source Waveform - Lower Dipole	WF_SAM1	
SSW2	STC Source Waveform - Upper Dipole	WF_SAM2	
STDLC	Subsequent Trip Down Log Correction	-50000	FT
STLL	Label Slowness Lower Limit - Monopole Stoneley	180	US/F
STUL	Label Slowness Upper Limit - Monopole Stoneley	780	US/F
SUL1	STC Slowness Upper Limit - Lower Dipole	775	US/F
SUL2	STC Slowness Upper Limit - Upper Dipole	775	US/F
SUL3	STC Slowness Upper Limit - Monopole Stoneley	775	US/F
SUL4	STC Slowness Upper Limit - Monopole P&S	775	US/F

SUL2	STC Slowness Upper Limit - Upper Dipole	775	US/F
SUL3	STC Slowness Upper Limit - Monopole Stoneley	780	US/F
SUL4	STC Slowness Upper Limit - Monopole P&S	240	US/F
SUOR	Susceptibility Operating Range	NORM	
SWD1	STC Slowness Width - Lower Dipole	40	US/F
SWD2	STC Slowness Width - Upper Dipole	40	US/F
SWD3	STC Slowness Width - Monopole Stoneley	40	US/F
SWD4	STC Slowness Width - Monopole P&S	10	US/F
TBF1	STC Time for Baseline Fill - Lower Dipole	0	US
TBF2	STC Time for Baseline Fill - Upper Dipole	0	US
TBF3	STC Time for Baseline Fill - Monopole Stoneley	0	US
TBF4	STC Time for Baseline Fill - Monopole P&S	300	US
TD	Total Depth	11470	FT
TDD	Total Depth - Driller	11154.00	FT
TDL	Total Depth - Logger	11154.00	FT
TLL1	STC Time Lower Limit - Lower Dipole	600	US
TLL2	STC Time Lower Limit - Upper Dipole	600	US
TLL3	STC Time Lower Limit - Monopole Stoneley	600	US
TLL4	STC Time Lower Limit - Monopole P&S	150	US
TMIN	Thorium Minimum	0	PPM
TNDCD	Tension Device Calibration Date (dd-MMM-yyyy)	dd-MMM-yyyy	
TNDCSN	Tension Device Calibrator Serial Number	-999	
TNDGN	Tension Device GAIN	1	
TNDOFF	Tension Device Offset	0	
TNDSN	Tension Device Serial Number	-999	
TNDTYP	Tension Device	CMTD-B/A	
TSHA	Thorium Shale	12	PPM
TST1	STC Time Step - Lower Dipole	200	US
TST2	STC Time Step - Upper Dipole	200	US
TST3	STC Time Step - Monopole Stoneley	200	US
TST4	STC Time Step - Monopole P&S	50	US
TUL1	STC Time Upper Limit - Lower Dipole	15912.5	US
TUL2	STC Time Upper Limit - Upper Dipole	15525	US
TUL3	STC Time Upper Limit - Monopole Stoneley	12000	US
TUL4	STC Time Upper Limit - Monopole P&S	3660	US
TWD1	STC Time Width - Lower Dipole	2000	US
TWD2	STC Time Width - Upper Dipole	2000	US
TWD3	STC Time Width - Monopole Stoneley	2000	US
TWD4	STC Time Width - Monopole P&S	1000	US
TWI1	STC Integration Time Window - Lower Dipole	1600	US
TWI2	STC Integration Time Window - Upper Dipole	1600	US
TWI3	STC Integration Time Window - Monopole Stoneley	2400	US
TWI4	STC Integration Time Window - Monopole P&S	500	US
TWRX	Transmitter Waveform Sample Rate X	5	US
TWS	Temperature of Connate Water Sample	100.00	DEGF
TWSX	Transmitter Waveform Select X	0	
UMIN	Uranium Minimum	0	PPM
USHA	Uranium Shale	3	PPM
UTXG	Upper Dipole Transmitter Geometry	162	IN
WFM1	Waveform Mode 1	W1	
WFM2	Waveform Mode 2	W1	
WFM3	Waveform Mode 3	W1	
WFM4	Waveform Mode 4	W1	
WFM5	Waveform Mode 5	W1	
WFMX	Waveform Mode X	W1	
ZRCS	Tool Zero Reference Check at Surface	-50000	FT

Format: DSST_P_S_VDL_COLOR Vertical Scale: 1:200 Graphics File Created: 03-May-2000 05:14

OP System Version: 9C1-303
MCM

GHMT-A	9C1-303	NGT-C	9C1-303
DTA-A	9C1-303	DSST-B	9C1-303
DTC-H	9C1-303		

Output DLIS Files

DEFAULT	GHMT .020	FN:33	PRODUCER	03-May-2000 05:14
GHMT_CUST	GHMT .020	FN:34	PRODUCER	03-May-2000 05:14

Calibration and Check Summary

Measurement	Nominal	Master	Before	After	Change	Limit	Units
Natural Gamma Spectroscopy - C Wellsite Calibration - Background Measurement							
Master: 16-APR-2000 21:24 Before: 16-APR-2000 21:30							

WINDOW 1 Background	100.0	9.898	9.716	N/A	N/A	100.0	CPS
WINDOW 2 Background	50.00	2.920	2.836	N/A	N/A	50.00	CPS
WINDOW 3 Background	10.00	0.6604	0.7863	N/A	N/A	10.00	CPS
WINDOW 4 Background	6.000	0.3249	0.2437	N/A	N/A	6.000	CPS
WINDOW 5 Background	10.00	0.5101	0.4025	N/A	N/A	10.00	CPS
SGR Background	30.00	3.745	3.658	N/A	N/A	N/A	GAPI

Natural Gamma Spectroscopy - C Wellsite Calibration - Normalized Jig Measurement

Master: 16-APR-2000 21:18 Before: 16-APR-2000 21:37

WINDOW 1 Jig	376.0	386.3	387.2	N/A	N/A	22.56	CPS
WINDOW 2 Jig	167.0	170.1	170.1	N/A	N/A	10.02	CPS
WINDOW 3 Jig	24.00	24.62	23.87	N/A	N/A	1.440	CPS
WINDOW 4 Jig	14.00	14.45	13.95	N/A	N/A	2.800	CPS
WINDOW 5 Jig	22.50	22.01	23.06	N/A	N/A	4.500	CPS
SGR Jig	160.0	159.8	160.0	N/A	N/A	7.000	GAPI

Natural Gamma Spectroscopy - C Master Calibration - Master Quality Control Values

Master: 16-APR-2000 21:13

Photomultiplier Res. CARC3	8.000	9.461	--	--	--	--	
APU WINDOW Jig	1350	964.6	--	--	--	--	CPS
APL WINDOW Jig	1350	964.2	--	--	--	--	CPS

The NGT PCSL Value is set to 83.674 KEV

Natural Gamma Spectroscopy - C / Equipment Identification

Primary Equipment:

NGT Cartridge	NGC - C	1921
NGT Sonde	NGD - A	1736

Auxiliary Equipment:

NGT Cartridge Housing	NGCH - A	752
NGT Sonde Housing	NGH - B	3
Gamma Source Radioactive	GSR - U	

Natural Gamma Spectroscopy - C Wellsite Calibration

Background Measurement

Phase	WINDOW 1 Background CPS	Value	Phase	WINDOW 2 Background CPS	Value	Phase	WINDOW 3 Background CPS	Value
Master		9.898	Master		2.920	Master		0.6604
Before		9.716	Before		2.836	Before		0.7863
	0 (Minimum) 100.0 (Nominal) 400.0 (Maximum)		0 (Minimum) 50.00 (Nominal) 200.0 (Maximum)		0 (Minimum) 10.00 (Nominal) 40.00 (Maximum)			
Phase	WINDOW 4 Background CPS	Value	Phase	WINDOW 5 Background CPS	Value	Phase	SGR Background GAPI	Value
Master		0.3249	Master		0.5101	Master		3.745
Before		0.2437	Before		0.4025	Before		3.658
	0 (Minimum) 6.000 (Nominal) 24.00 (Maximum)		0 (Minimum) 10.00 (Nominal) 40.00 (Maximum)		0 (Minimum) 30.00 (Nominal) 120.0 (Maximum)			

Master: 16-APR-2000 21:24 Before: 16-APR-2000 21:30

Natural Gamma Spectroscopy - C Wellsite Calibration

Normalized Jig Measurement

Phase	WINDOW 1 Jig CPS	Value	Phase	WINDOW 2 Jig CPS	Value	Phase	WINDOW 3 Jig CPS	Value
Master		386.3	Master		170.1	Master		24.62
Before		387.2	Before		170.1	Before		23.87
	354.0 (Minimum) 376.0 (Nominal) 398.0 (Maximum)		155.0 (Minimum) 167.0 (Nominal) 179.0 (Maximum)		21.50 (Minimum) 24.00 (Nominal) 26.50 (Maximum)			
Phase	WINDOW 4 Jig CPS	Value	Phase	WINDOW 5 Jig CPS	Value	Phase	SGR Jig GAPI	Value
Master		14.45	Master		22.01	Master		159.8
Before		13.95	Before		23.06	Before		160.0
	12.50 (Minimum) 14.00 (Nominal) 15.50 (Maximum)		20.00 (Minimum) 22.50 (Nominal) 25.00 (Maximum)		148.0 (Minimum) 160.0 (Nominal) 172.0 (Maximum)			

Master: 16-APR-2000 21:18 Before: 16-APR-2000 21:37

Natural Gamma Spectroscopy - C Wellsite Calibration

Quality Control Values

Phase	DHVF Jig V	Value	Phase	Quality Windows Ratio Jig	Value	
Master		1515	Master		2.271	
Before		1514	Before		2.277	
	1088 (Minimum)	1450 (Nominal)	1813 (Maximum)	2.150 (Minimum)	2.240 (Nominal)	2.330 (Maximum)
Master: 16-APR-2000 21:18			Before: 16-APR-2000 21:37			

Natural Gamma Spectroscopy - C Wellsite Calibration			
Quality Control Values Check			
Phase	Thorium peak Form Factor Jig	Value	
Before		0.01462	
	-0.2000 (Minimum)	0 (Nominal)	0.2000 (Maximum)
Before: 16-APR-2000 21:37			

Natural Gamma Spectroscopy - C Master Calibration											
Master Quality Control Values											
Phase	Photomultiplier Res. CARC3		Value	Phase	APU WINDOW Jig CPS		Value	Phase	APL WINDOW Jig CPS		Value
Master			9.461	Master			964.6	Master			964.2
	4.500 (Minimum)	8.000 (Nominal)	11.50 (Maximum)		700.0 (Minimum)	1350 (Nominal)	1600 (Maximum)		700.0 (Minimum)	1350 (Nominal)	1600 (Maximum)
Phase	Thorium peak Form Factor Jig		Value								
Master			-0.02200								
	-0.1000 (Minimum)	0 (Nominal)	0.1000 (Maximum)								
Master: 16-APR-2000 21:13											

COMPANY: Lamont Doherty

WELL: ODP Leg 189, Site 1172D (ETP-2A)

FIELD: East Tasmania

COUNTY: Offshore

STATE: Pacific Ocean

BOTTOM LOG INTERVAL 3372 m

SCHLUMBERGER DEPTH 3395 m

DEPTH DRILLER 3399.85 m

KELLY BUSHING 11.2 m

DRILL FLOOR 10.9 m

GROUND LEVEL 2621.7 m

Schlumberger

P&S Dipole Sonic
Natural Gamma Ray