

Company: **LDEO Borehole Research Group**

Well: **1188B** **PCM-2A**

Field: **Eastern Manus Back Arc Basin**

Rig: **JOIDES Resolution**

Rig: JOIDES Resolution Field: Eastern Manus Back Arc Basin Location: Bismarck Sea, PNG Well: 1188B Company: LDEO Borehole Research Group	Schlumberger		RAB Deep Button Image Measured Depth Scale 1:200			
			Total depth:	1725 m	Elevation	K.B.
Location		Spud date:	25 Nov 00	G.L.		-1642.1 m
		Runs:	1 To 1	D.F.	10.5 m	
		Permanent datum:	Mean Sea Level	Elev.:	Kelly Bushing	
		Log measured from:	Top of kelly bushing	10.9 m	above Perm. datum	
		Depth reference:	Driller's Pipe Tally			
API serial no.		Logging Services:	Longitude	Latitude		
		RAB	E 151 40.1981'	S 03 43.6962'		
Depth logged:		1653 m To 1725 m	Mag decl:	6.56 deg	Other services:	
Date logged:		25 Nov 00 To 26 Nov 00	Mag dip:	-21.78 deg		
Bore hole record			Casing record			
Hole size	from	to	Size	Density	from to	
9.875 in	1653 m	1725 m				
Mud record			Borehole deviation record			
Type	from	to	Min	Max	from to	
Sea Water	1653 m	1725 m				
Surface equipment		Software record		IDEAL services from Anadrill		
Unit	TWIS	IDEAL Wis	6.1c_03			
Depth system	PDA	SPM	6.1c_03			
		LWD	5.0b_12			
		MWD				

Bit Run Summary

Run number	1
Bit size	9.875 in
Bit start depth	1653 m
Bit end depth	1725 m
Top interval logged	1653 m
Bottom interval logged	1719 m
Begin log: time	16:15
Begin log: date	25 Nov 00
End log: time	04:15
End log: date	26 Nov 00
Mud data	
Depth	1653 m
Type	Sea Water

Type		Sea Water								
Mud weight	ppg	8.9								
Solids										
Chlorides										
Rm	ohm.m @ degC	0.222 @ 24								
Rmf										
Rmc										
Potassium										
Environmental data										
GR										
Mud weight	ppg	8.9								
Bit size	in	9.875								
Resistivity										
Neutron porosity										
Hole Size										
Mud weight										
Temperature										
Mud salinity										
Formation salinity										
Recording rate 1	SEC	20								
Recording rate 2	SEC	20								
Filtering GR		3 point av.								
Filtering density										
Filtering Neutron										
Company representative		G.Iturrino	A.Bartetzko	M.Storms						
Anadrill personnel		A.Strahan								

DISCLAIMER

THE USE OF AND RELIANCE UPON THIS RECORDED-DATA BY THE HEREIN NAMED COMPANY (AND ANY OF ITS AFFILIATES, PARTNERS, REPRESENTATIVES, AGENTS, CONSULTANTS AND EMPLOYEES) IS SUBJECT TO THE TERMS AND CONDITIONS AGREED UPON BETWEEN SCHLUMBERGER AND THE COMPANY, INCLUDING: (a) RESTRICTIONS ON USE OF THE RECORDED-DATA; (b) DISCLAIMERS AND WAIVERS OF WARRANTIES AND REPRESENTATIONS REGARDING COMPANY'S USE OF AND RELIANCE UPON THE RECORDED-DATA; AND (c) CUSTOMER'S FULL AND SOLE RESPONSIBILITY FOR ANY INFERENCE DRAWN OR DECISION MADE IN CONNECTION WITH THE USE OF THIS RECORDED-DATA.

OTHER SERVICES FOR RUN 1	OTHER SERVICES FOR RUN	OTHER SERVICES FOR RUN
<p>REMARKS: RUN NUMBER 1</p> <p>RAB data acquired in memory mode while drilling from 1653-1725 m</p> <p>Drilled in rotary mode</p> <p>Depth filtered for heave</p> <p>No surveys available – borehole assumed to be vertical</p> <p>Environmental Corrections Applied:</p> <p>GR – borehole size, mud weight</p> <p>Resistivity – borehole size, mud resistivity</p> <p>borehole temperature</p> <p>Rbit measurement is affected by a large vertical resolution (4.30 m)</p> <p>25 Nov 00</p> <p>8:28 Program RAB</p> <p>9:00 BHA below rotary table</p> <p>16:15 On bottom drilling at 1653 m</p> <p>25 Nov 00</p> <p>4:15 TD at 1725 m</p> <p>13:00 BHA above rotary table – retrieve RAB memory data</p>	<p>REMARKS: RUN NUMBER</p>	<p>REMARKS: RUN NUMBER</p>

13:00 BHA above rotary table – retrieve
 RAB memory data

EQUIPMENT DESCRIPTION

RUN1

RUN

RUN

DOWNHOLE E

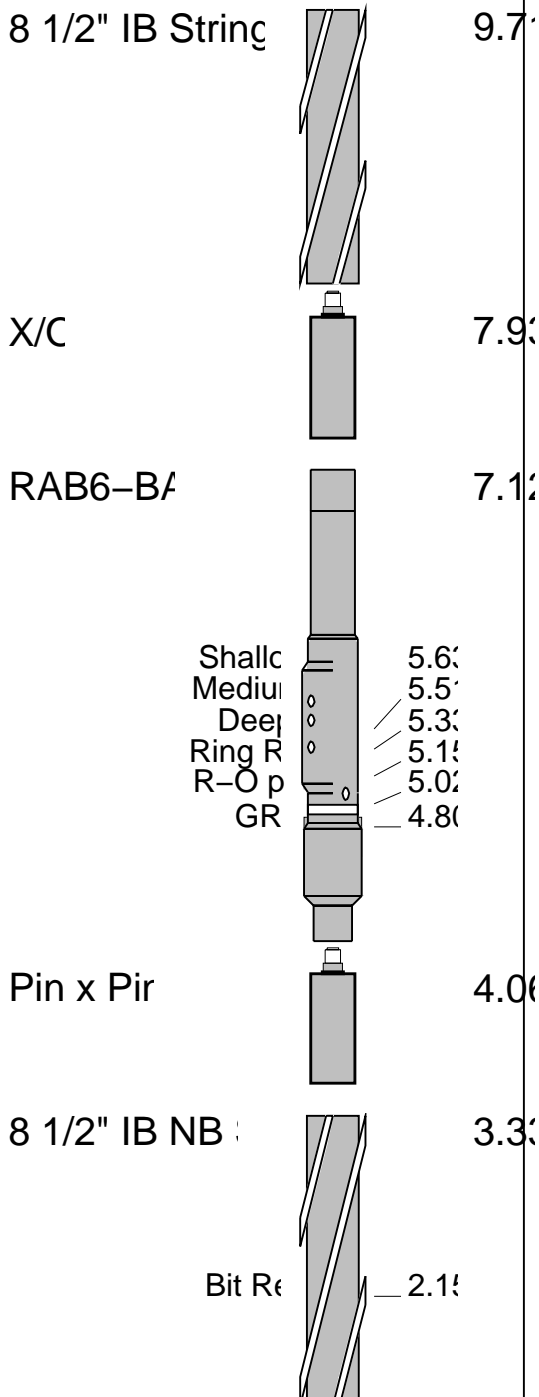

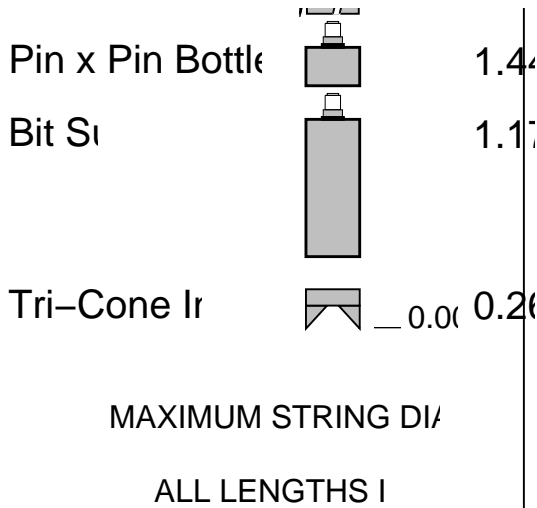

Output DLIS Files

ODP_DLIS RAB .028 FN:19 PRODUCER 30-Dec-2000 07:53

IDEAL Version: ID6_1C_03

IDEAL

RAB6-BA id6_1c_03

Format: RABIMAGELOG Vertical Scale: 1:200

Graphics File Created: 30-Dec-2000 07:53

Parameters

DLIS Name	Description	Value
	RAB: Button Sleeve Diameter	RAB6: 8 1/8 IN
	LWD RM: Log direction	DOWN
	LWD RM: Default directory	D:\users\ideal\fm\Clients\ODP\PCM_2a\LWD001\
	LWD RM: Default file extension	BIN_DB
	RAB: Stabilizer Diameter	RAB6: 8.25-8.5 IN
	LWD RM: Generate techlog only?	0
	LWD RM: Flush depth streams?	YES
	LWD RM: Depth file name	Depth_Edit_Filter_1
BDBHCA	RAB: Button Deep Borehole A Factor	0.0875262
BDBHCB	RAB: Button Deep Borehole B Factor	-0.0807475
BHA_COEF_VER	RAB: BHA Coef Generator Version	2
BITBHCA	RAB: Bit A Borehole Factor	0.103963
BITBHCB	RAB: Bit B Borehole Factor	-0.0565331
BIT_K_FACTOR	RAB: Bit K Factor	7.06036
BMBHCA	RAB: Button Medium Borehole A Factor	0.0972245
BMBHCB	RAB: Button Medium Borehole B Factor	-0.113513
BSBHCA	RAB: Button Shallow Borehole A Factor	0.319025
BSBHCB	RAB: Button Shallow Borehole B Factor	-0.0581583
BS_RM	Bit Size (RM)	9.875 IN
BUT_KIMP_A	RAB: Button Impedance Coeff A	0.00149
BUT_KIMP_B	RAB: Button Impedance Coeff B	3.6e-005
DBUTTON_K_FACTOR	RAB: Button Deep K factor	0.00271955
DHS_VERSION	RAB: DownHole Software Version	5.0012
DIPR	magnetic dip	-21.78 DEG
IMAGE_MAX_RES	RAB: Image Maximum Resistivity Value	100 OHMM
IMAGE_MIN_RES	RAB: Image Minimum Resistivity Value	1 OHMM
MBUTTON_K_FACTOR	RAB: Button Medium K Factor	0.00303524
MDCP	magnetic declination	6.56002 DEG
MST_RM	Mud Sample temperature (RM)	24.4445 DEGC
MW_RM	Mud Weight (RM)	8.9 LB/G
OBM	RAB: Oil base Mud	NO
ORIENTATION_RM	Rab Image Orientation	NORTH
RABEC	RAB: Resistivity Env-Cor	YES
RAB_TEMP_SELECT	RAB Temperature Selection	MEASURED
READOUT_PORT_MP	RAB: ROP to Bit Face Distance	5.02 M
RINGBHCA	RAB: Ring Borehole A Factor	0.167792

READOUT_PORT_MP	RAB: ROP to Bit Face Distance	5.02	M
RINGBHCA	RAB: Ring Borehole A Factor	0.167792	
RINGBHCB	RAB: Ring Borehole B Factor	-0.0836022	
RING_KIMP_A	RAB: Ring Impedance Coeff A	0	
RING_KIMP_B	RAB: Ring Impedance Coeff B	0	
RING_K_FACTOR	RAB: Ring K Factor	0.107365	
RMS_RM	Resistivity of Mud Sample (RM)	0.222	OHMM
SBUTTON_K_FACTOR	RAB: Button Shallow K Factor	0.00418338	
STAB	RAB: Run with Stabilizer	YES	
TOOLTYPE	RAB: Azimuthal Tool	YES	
TS_VERSION	RAB: ToolScope Software Version	6.1013	
VRAB6	Rab Tool type (ENP/PILOT)	RAB6_PILOT	
WIN_SIZE_DYN_IMAGE	RAB: Window Size for Scaling Dynamic Image	0.9144	M

PIP SUMMARY

- ┆ RAB Deep Button Samples
- ┆ Gamma Ray Samples

	BHC Ring Resistivity (RES_RING)	0.2	(OHMM)	2000
	BHC Bit resistivity (RES_BIT)	0.2	(OHMM)	2000
Rate of penetration, 5ft filtered (ROP5_RM)		60	(M/HR)	0
Deep Button Resistivity Time After Bit (TAB_RAB_BD)		0	(HR)	10
	BHC Deep Button Resistivity (RES_BD)	0.2	(OHMM)	2000
	BHC Medium Button Resistivity (RES_BM)	0.2	(OHMM)	2000

RAB Gamma Ray (GR_RAB)	RAB Rotational Speed (RPM_RAB)	0	(GAPI)	200
		250	(RPM)	-10
	RAB Deep button Image (R3IM)			
	BHC Shallow Button Resistivity (RES_BS)	0.2	(OHMM)	2000

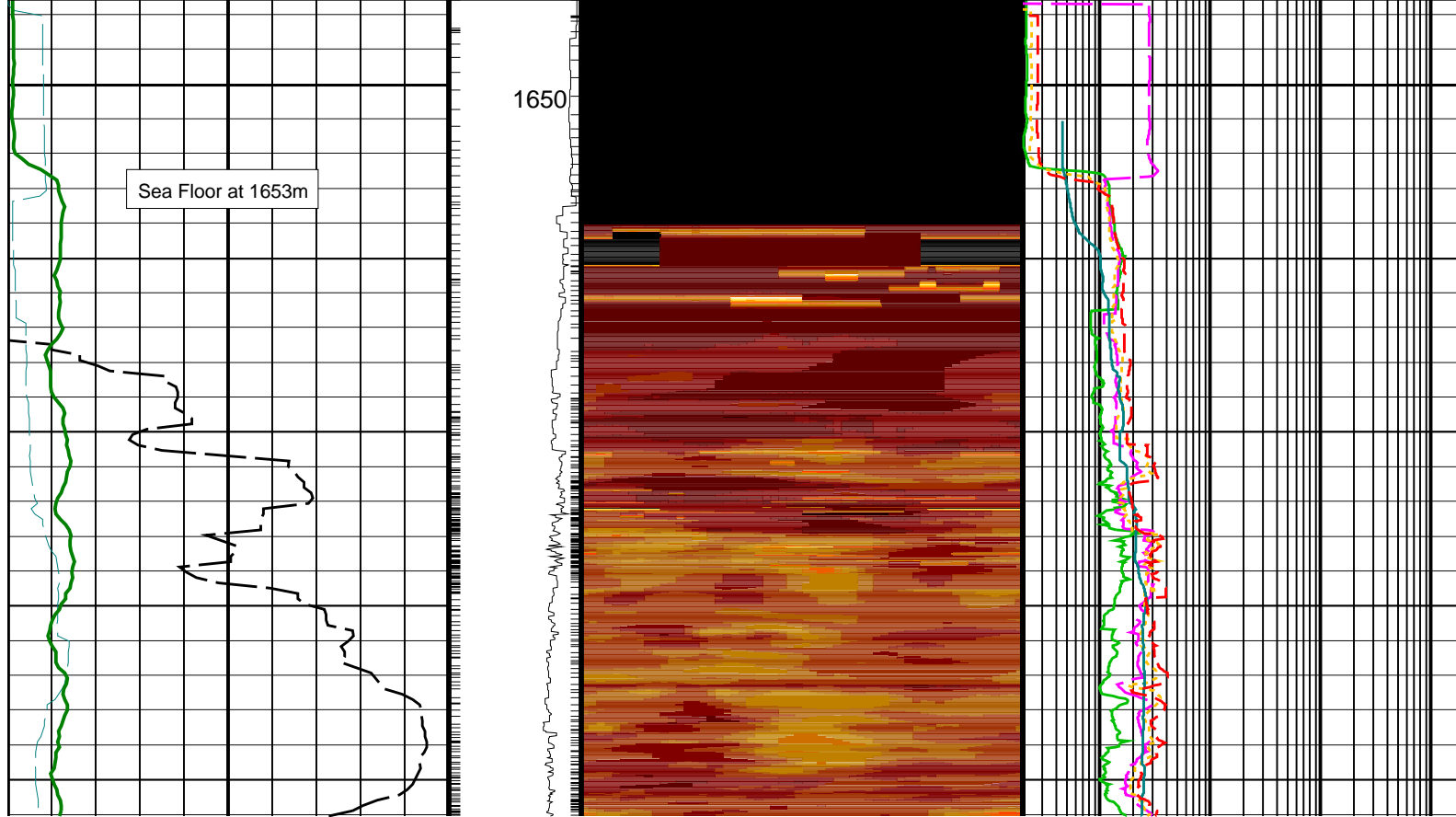

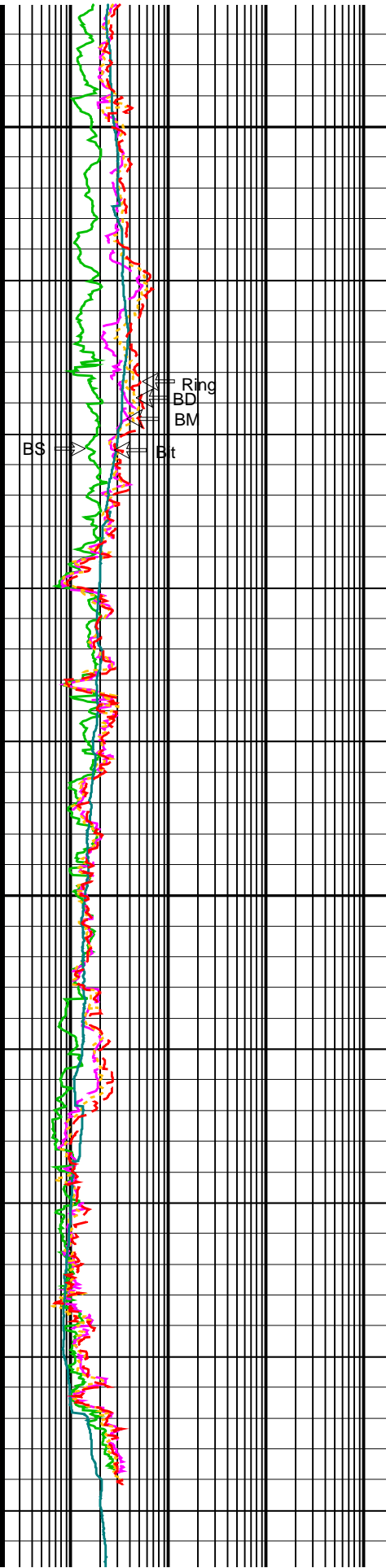
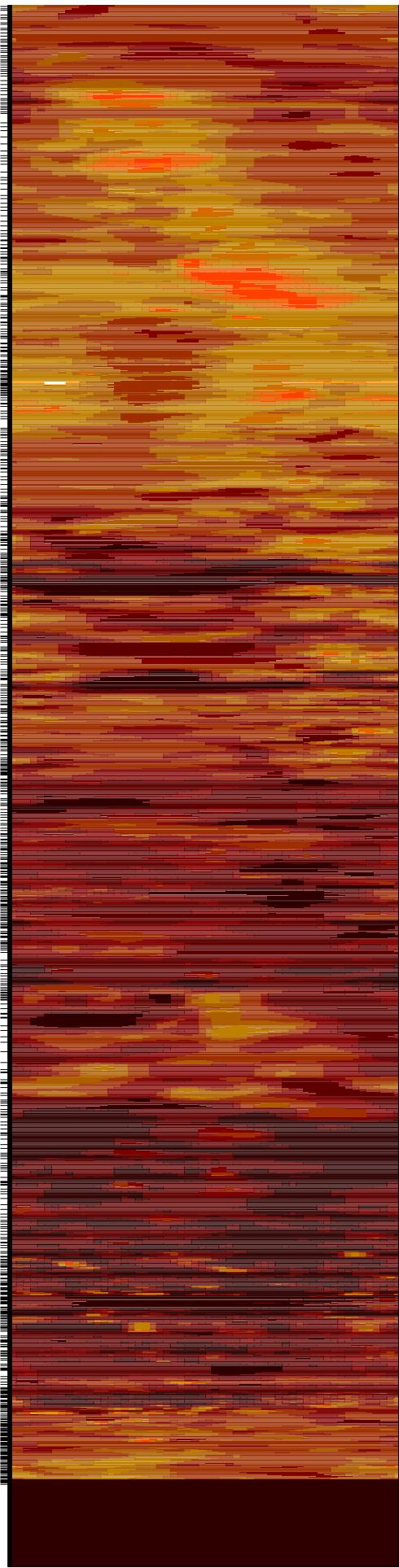
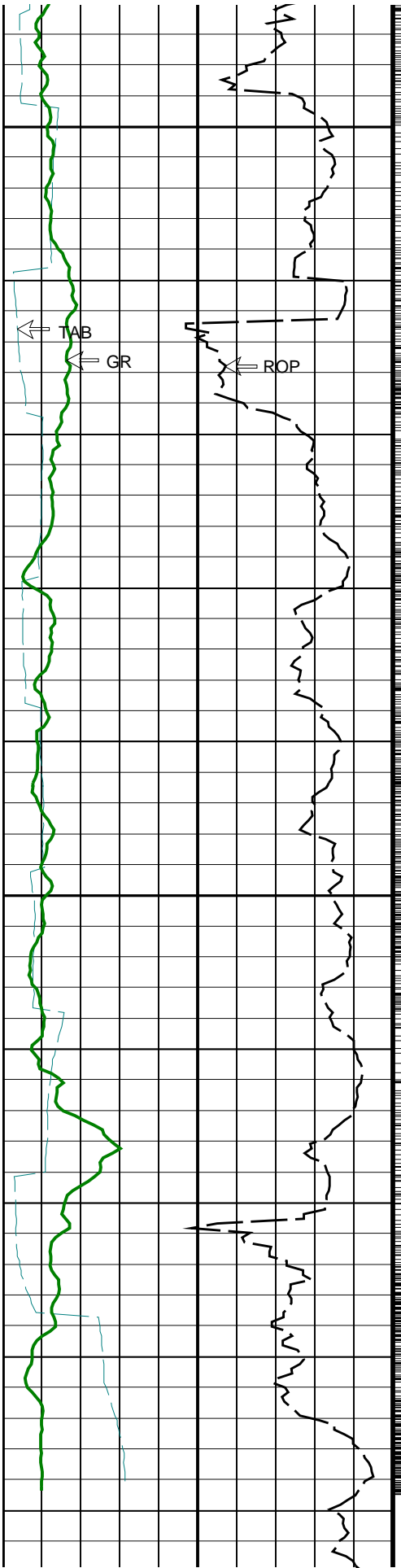

TD at 1725m

RAB Gamma Ray (GR_RAB)		
0	(GAPI)	200
Deep Button Resistivity Time After Bit (TAB_RAB_BD)		
0	(HR)	10
Rate of penetration, 5ft filtered (ROP5_RM)		
60	(M/HR)	0

RAB Rotational Speed (RPM_RAB) (RPM)
250 -10

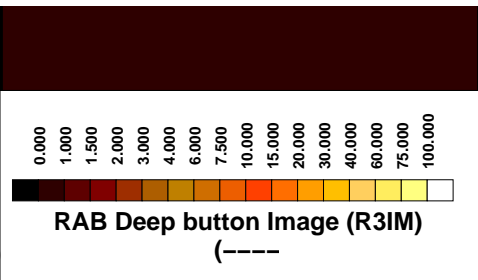

BHC Shallow Button Resistivity (RES_BS)		
0.2	(OHMM)	2000
BHC Medium Button Resistivity (RES_BM)		
0.2	(OHMM)	2000
BHC Deep Button Resistivity (RES_BD)		
0.2	(OHMM)	2000
BHC Bit resistivity (RES_BIT)		
0.2	(OHMM)	2000
BHC Ring Resistivity (RES_RING)		
0.2	(OHMM)	2000

PIP SUMMARY
 + RAB Deep Button Samples
 + Gamma Ray Samples

IDEAL Version: ID6_1C_03
 IDEAL

RAB6-BA id6_1c_03

Output DLIS Files

ODP_DLIS RAB .028 FN:19 PRODUCER 30-Dec-2000 07:53 1647.6 M 1724.2 M

6.75-in. Resistivity At-the-Bit / Equipment Identification

Primary Equipment:
 Tool Name and Serial Number RAB6 - BA 48
 Calibration Status -

Master: 24-NOV-2000 23:22

6.75-in. Resistivity At-the-Bit Calibration														
Resistivity: Fixture														
Phase	Ring/T1 factor			Value	Phase	Ring/T2 factor			Value	Phase	M0/T1 factor			Value
Master				0.01081	Master				0.01079	Master				1.105
	0.009500 (Minimum)	0.01100 (Nominal)	0.01250 (Maximum)			0.009500 (Minimum)	0.01100 (Nominal)	0.01250 (Maximum)			0.9000 (Minimum)	1.050 (Nominal)	1.200 (Maximum)	
Phase	M0/T2 factor			Value	Phase	M2/T1 factor			Value	Phase	M2/T2 factor			Value
Master				1.137	Master				0.9956	Master				1.024
	0.9000 (Minimum)	1.050 (Nominal)	1.200 (Maximum)			0.8500 (Minimum)	1.000 (Nominal)	1.150 (Maximum)			0.8500 (Minimum)	1.000 (Nominal)	1.150 (Maximum)	
Phase	BTN shallow/T1 factor			Value	Phase	BTN shallow/T2 factor			Value	Phase	BTN medium/T1 factor			Value
Master				0.0006530	Master				0.0006840	Master				0.0006630
	0.0005700 (Minimum)	0.0006700 (Nominal)	0.0007700 (Maximum)			0.0005700 (Minimum)	0.0006700 (Nominal)	0.0007700 (Maximum)			0.0005700 (Minimum)	0.0006700 (Nominal)	0.0007700 (Maximum)	
Phase	BTN medium/T2 factor			Value	Phase	BTN deep/T1 factor			Value	Phase	BTN deep/T2 factor			Value
Master				0.0006550	Master				0.0006740	Master				0.0006630

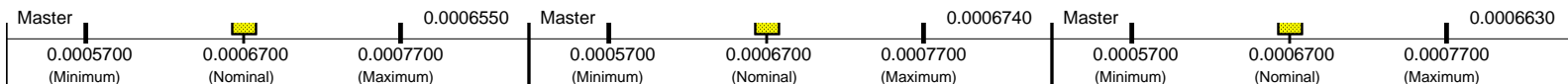

Master: 24-NOV-2000 23:16		
6.75-in. Resistivity At-the-Bit Calibration		
Gamma Ray: Blanket		
Phase	Gamma ray factor	Value
Master		4.110
	3.500 (Minimum) 4.500 (Nominal) 5.500 (Maximum)	

Company: **LDEO Borehole Research Group**

Well: **1188B** **PCM-2A**

Field: **Eastern Manus Back Arc Basin**

Rig: **JOIDES Resolution**

IDEAL services from **Anadrill**

RAB Deep Button Image
Measured Depth
Scale 1:200

Schlumberger