

Company: Lamont Doherty
Well: ODP Leg 202, Site 1239A
Field: Carnegie Ridge
Country: Ecuador

Ocean: Pacific Ocean

Phasor Induction- Natural Gamma Ray

Country: Ecuador
Field: Carnegie Ridge
Location: Rig- Joides Resolution
Well: ODP Leg 202, Site 1239A
Company: Lamont Doherty

LOCATION		Elev.:	K.B.	11.3 m
Rig- Joides Resolution			G.L.	-1426.1 m
			D.F.	11 m
Permanent Datum:		GROUND LEVEL		
Log Measured From: _____		DES	above Perm. Datum	
Drilling Measured From: _____		DES		
API Serial No.	Max. Hole Devi.	Longitude	Latitude	
		82 04.8512 W	.40.395 S	

Logging Date				
Run Number	1			
Depth Driller	1941.5 m			
Schlumberger Depth	1941 m			
Bottom Log Interval	1939 m			
Top Log Interval	1418.7 m			
Casing Driller Size @ Depth	0.000 in @ 1506.1 m		@	
Casing Schlumberger	1505 m			
Bit Size	11.437 in			
Type Fluid In Hole				
Type Fluid In Hole				
Density	Viscosity	1.066 g/cm3		
Fluid Loss	PH			
Source Of Sample				
RM @ Measured Temperature	@	23 degC	@	
RMF @ Measured Temperature	@		@	
RMC @ Measured Temperature	@		@	
Source RMF	RMC			
RM @ MRT	RMF @ MRT	@	@	@
Maximum Recorded Temperatures				
Circulation Stopped	Time	5/12/02	1400	
Logger On Bottom	Time	5/12/02	See Log	
Unit Number	Location	99	Houston	
Recorded By		Steve Kittredge		
Witnessed By		Ule Ninmemann		

Logging Date	Run 1	Run 2	Run
Run Number			
Depth Driller			
Schlumberger Depth			
Bottom Log Interval			
Top Log Interval			
Casing Driller Size @ Depth	@		
Casing Schlumberger			
Bit Size			
Type Fluid In Hole			
Type Fluid In Hole			
Density	Viscosity		
Fluid Loss	PH		
Source Of Sample			
RM @ Measured Temperature	@		
RMF @ Measured Temperature	@		
RMC @ Measured Temperature	@		
Source RMF	RMC		
RM @ MRT	RMF @ MRT	@	@
Maximum Recorded Temperatures			
Circulation Stopped	Time		
Logger On Bottom	Time		
Unit Number	Location		
Recorded By		Steve Kittredge	
Witnessed By		Ule Ninmemann	

Logging Date				
Run Number	1			
Depth Driller	1941.5 m			
Schlumberger Depth	1941 m			
Bottom Log Interval	1939 m			
Top Log Interval	1418.7 m			
Casing Driller Size @ Depth	0.000 in @ 1506.1 m		@	
Casing Schlumberger	1505 m			
Bit Size	11.437 in			
Type Fluid In Hole				
Type Fluid In Hole				
Density	Viscosity	1.066 g/cm3		
Fluid Loss	PH			
Source Of Sample				
RM @ Measured Temperature	@	23 degC	@	
RMF @ Measured Temperature	@		@	
RMC @ Measured Temperature	@		@	
Source RMF	RMC			
RM @ MRT	RMF @ MRT	@	@	@
Maximum Recorded Temperatures				
Circulation Stopped	Time	5/12/02	1400	
Logger On Bottom	Time	5/12/02	See Log	
Unit Number	Location	99	Houston	
Recorded By		Steve Kittredge		
Witnessed By		Ule Ninmemann		

DISCLAIMER

THE USE OF AND RELIANCE UPON THIS RECORDED-DATA BY THE HEREIN NAMED COMPANY (AND ANY OF ITS AFFILIATES, PARTNERS, REPRESENTATIVES, AGENTS, CONSULTANTS AND EMPLOYEES) IS SUBJECT TO THE TERMS AND CONDITIONS AGREED UPON BETWEEN SCHLUMBERGER AND THE COMPANY, INCLUDING: (a) RESTRICTIONS ON USE OF THE RECORDED-DATA; (b) DISCLAIMERS AND WAIVERS OF WARRANTIES AND REPRESENTATIONS REGARDING COMPANY'S USE OF AND RELIANCE UPON THE RECORDED-DATA; AND (c) CUSTOMER'S FULL AND SOLE RESPONSIBILITY FOR ANY INFERENCE DRAWN OR DECISION MADE IN CONNECTION WITH THE USE OF THIS RECORDED-DATA.

OTHER SERVICES1
OS1: MESTB/DSI
OS2:
OS3:
OS4:
OS5:

OTHER SERVICES2
OS1:
OS2:
OS3:
OS4:
OS5:

REMARKS: RUN NUMBER 1
Hole Cored with APC/XCB.
All depths in Meters Below Rig Floor (MBRF).
Lamont Temperature tool was run
WHC was run.
Sea Floor Driller- 1426.1 MBRF>
Total Depth Driller- 1941.5 MBRF.
Total Depth Logger- 1941 MBRF.
Drill Pipe Driller- 1506.1 MBRF.
Drill Pipe Logger- 1505 MBRF.
Lamont MGT tool was run.

REMARKS: RUN NUMBER 2

RUN 1
SERVICE ORDER #:
PROGRAM VERSION: 10C0-306
FLUID LEVEL:

RUN 2
SERVICE ORDER #:
PROGRAM VERSION:
FLUID LEVEL:

LOGGED INTERVAL	START	STOP



LOGGED INTERVAL	START	STOP

EQUIPMENT DESCRIPTION

RUN 1
SURFACE EQUIPMENT
SFT-281 24
SFT-178 4722
GSR-U 135
DTM-B

RUN 2

DOWNHOLE EQUIPMENT

LEH-QT		34.33
LEH-QT		
AH-MGT2		33.44
AH-MGT2		

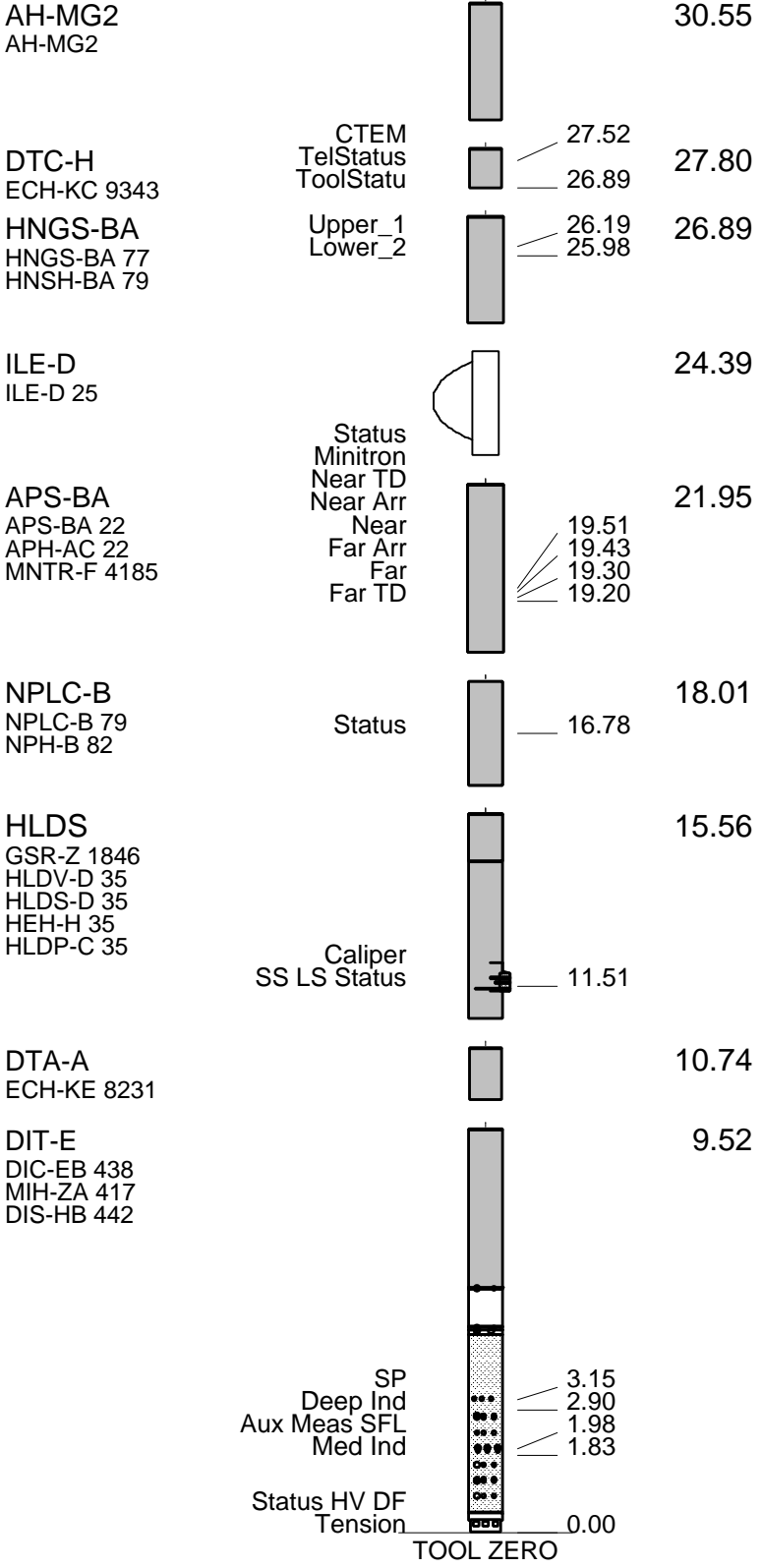

MAXIMUM STRING DIAMETER 3.88 IN
 MEASUREMENTS RELATIVE TO TOOL ZERO
 ALL LENGTHS IN METERS

Output DLIS Files

DEFAULT	PI_LDL_APS_NGS_007LUP	FN:8	PRODUCER	12-May-2002 17:59	1940.8 M	1418.7 M
TCOMBO_CSUT	PI_LDL_APS_NGS_007LUP	FN:9	PRODUCER	12-May-2002 17:59	1940.8 M	1418.7 M

OP System Version: 10C0-306
MCM

MAIN UP LOG

DIT-E	10C0-306	DTA-A	10C0-306
HLDS	10C0-306	NPLC-B	10C0-306
APS-BA	10C0-306	HNGS-BA	10C0-306
DTC-H	10C0-306		

Changed Parameter Summary

DLIS Name	New Value	Previous Value	Depth & Time
GCSE	BS	LCAL	1513.6 19:39:11

PIP SUMMARY

▶ Time Mark Every 60 S

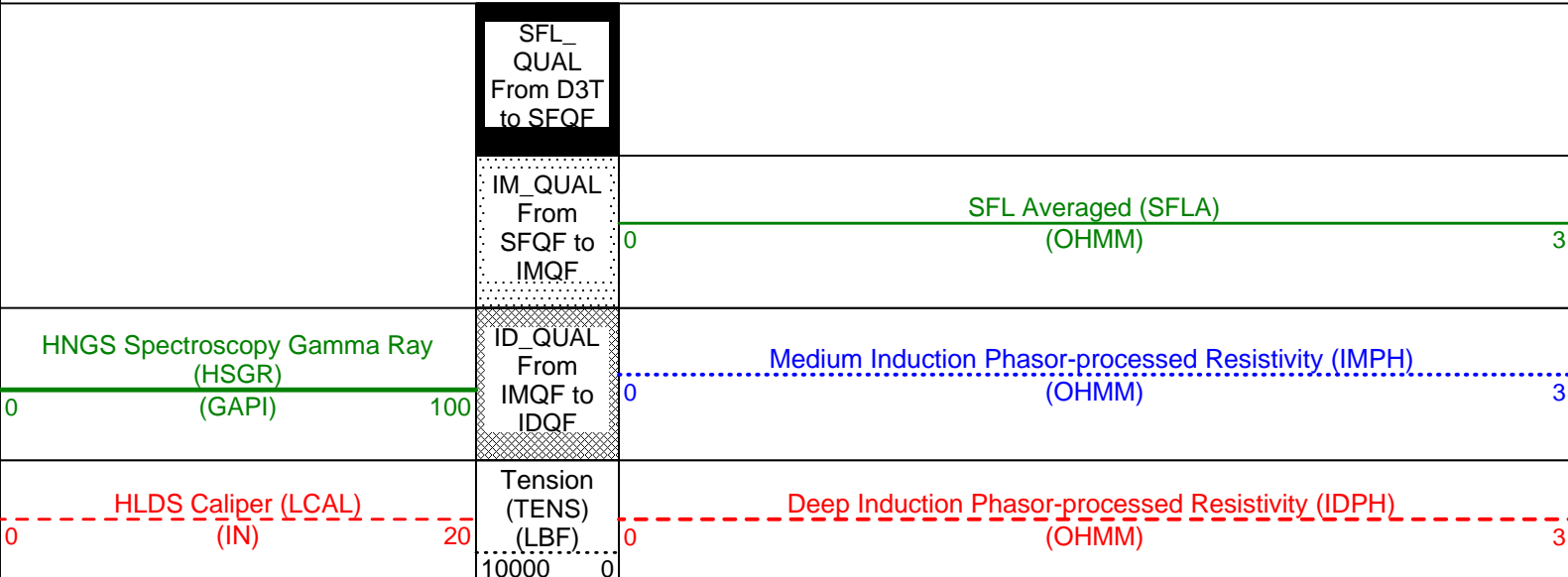

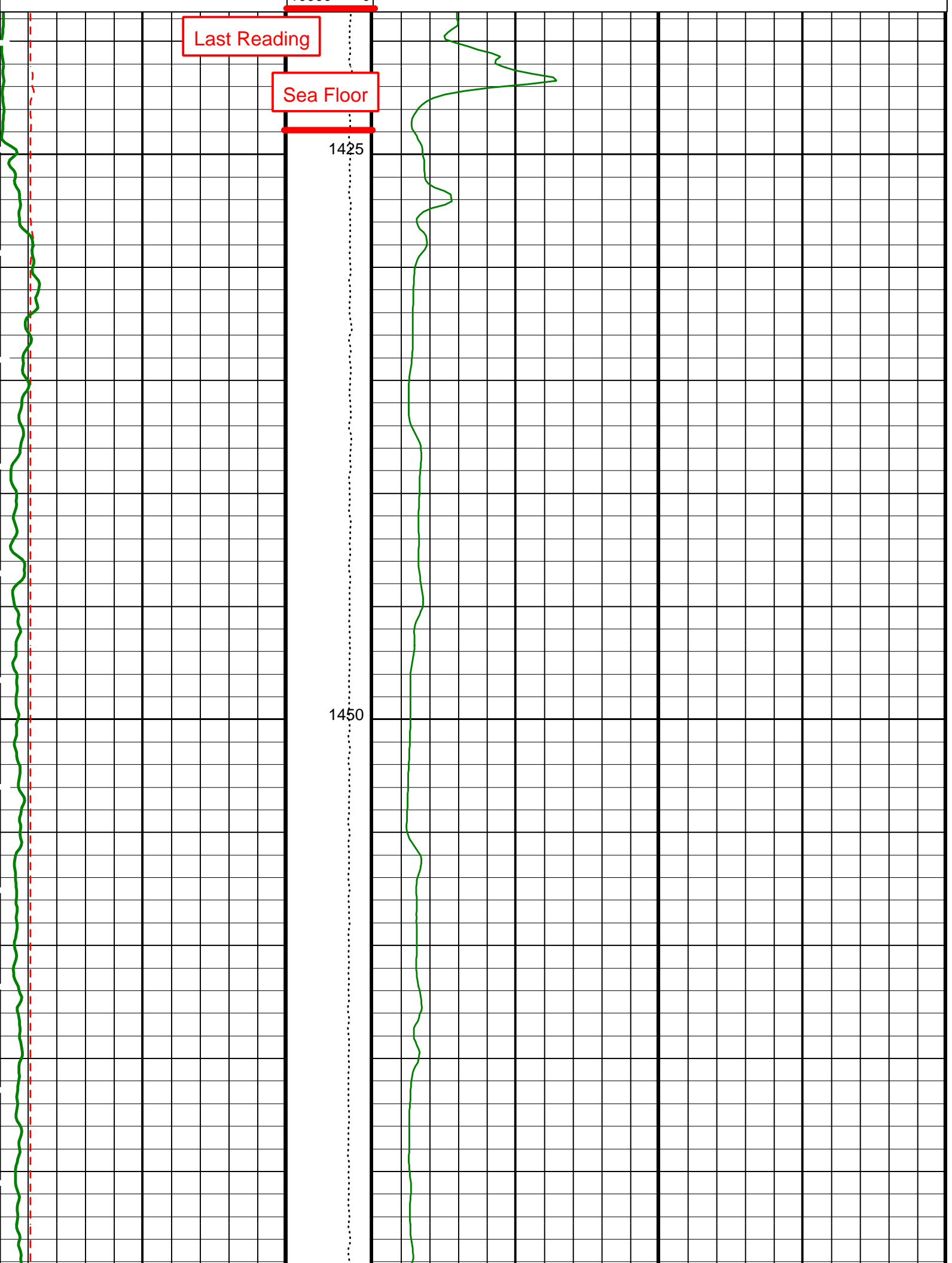

Last Reading

Sea Floor

1425

1450

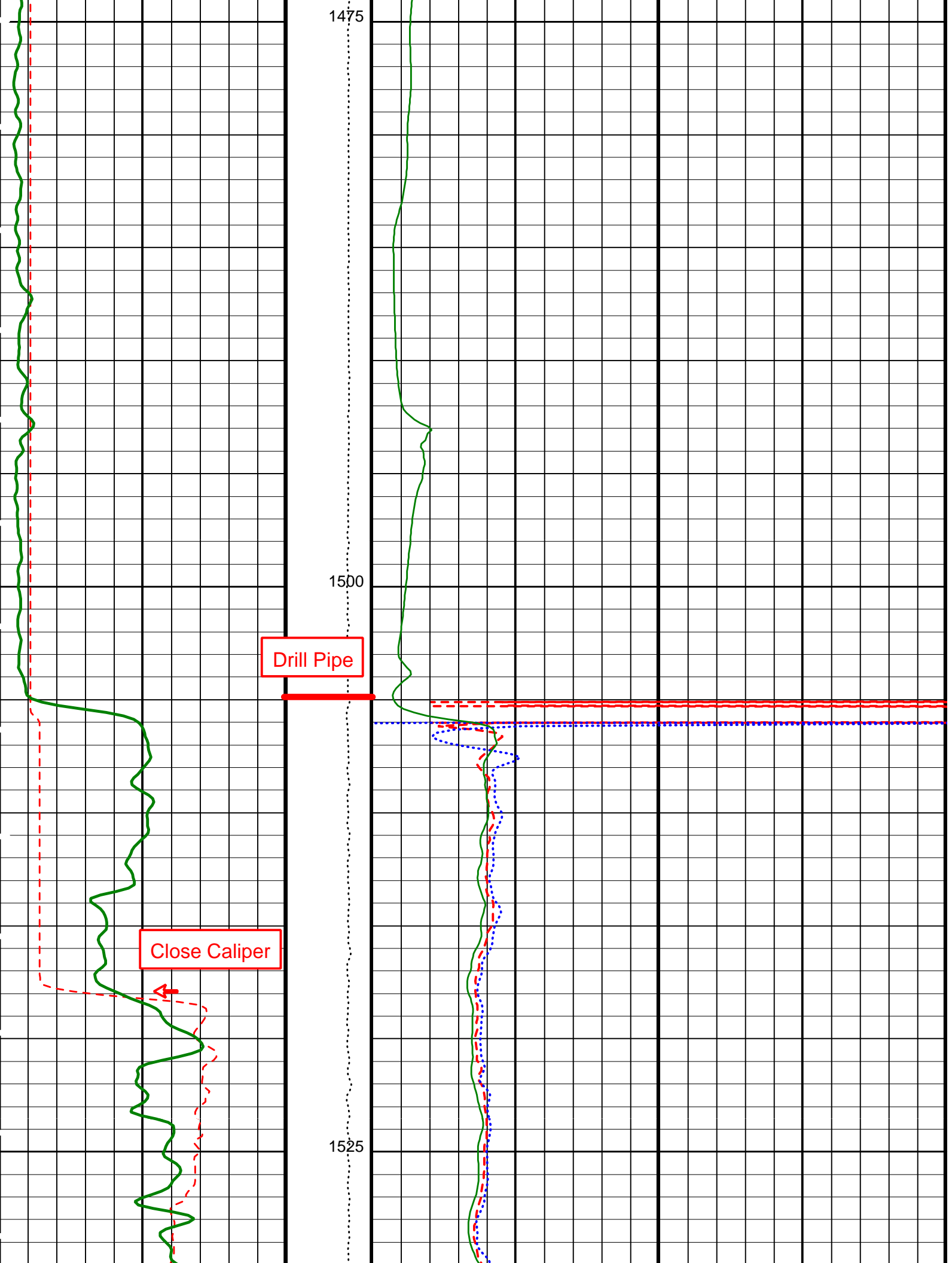

1475

1500

1525

Drill Pipe

Close Caliper

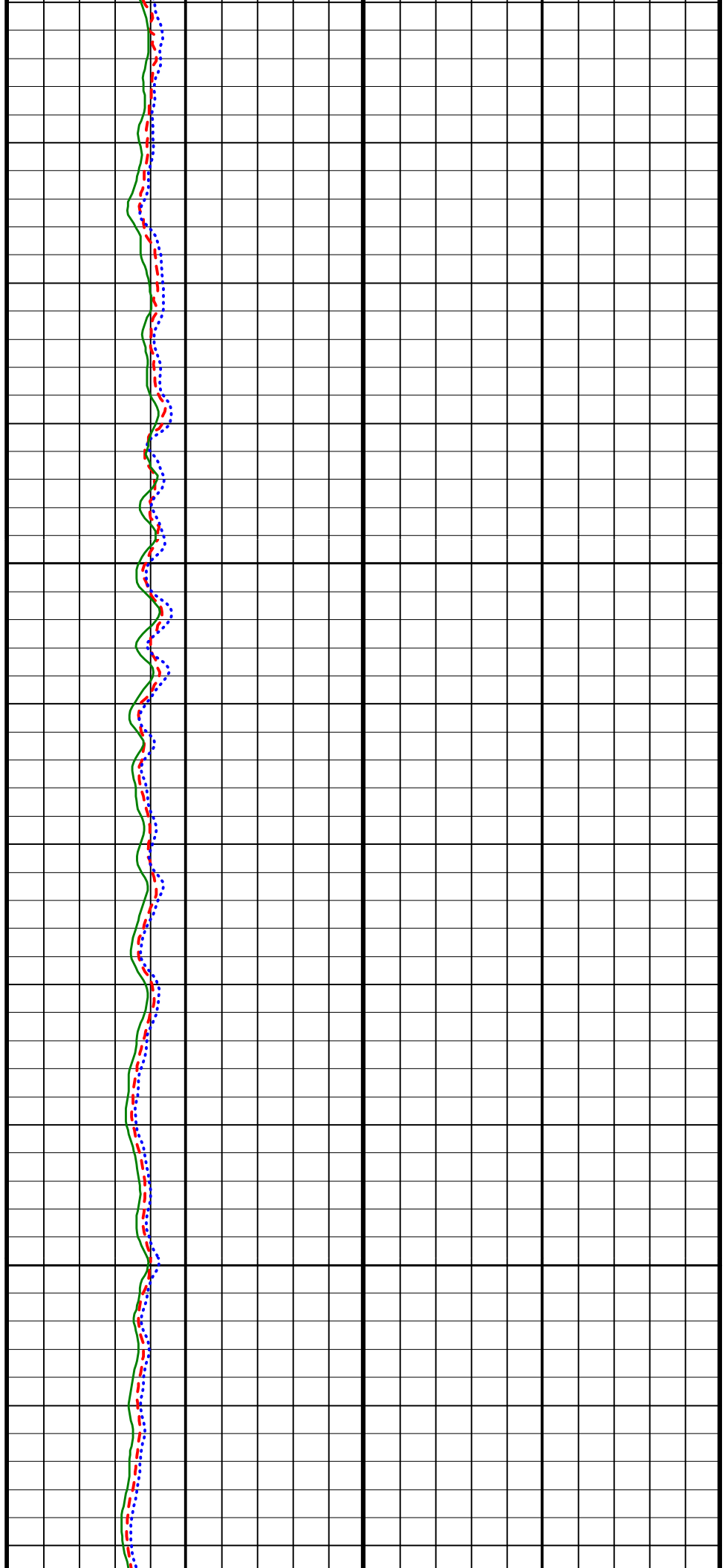
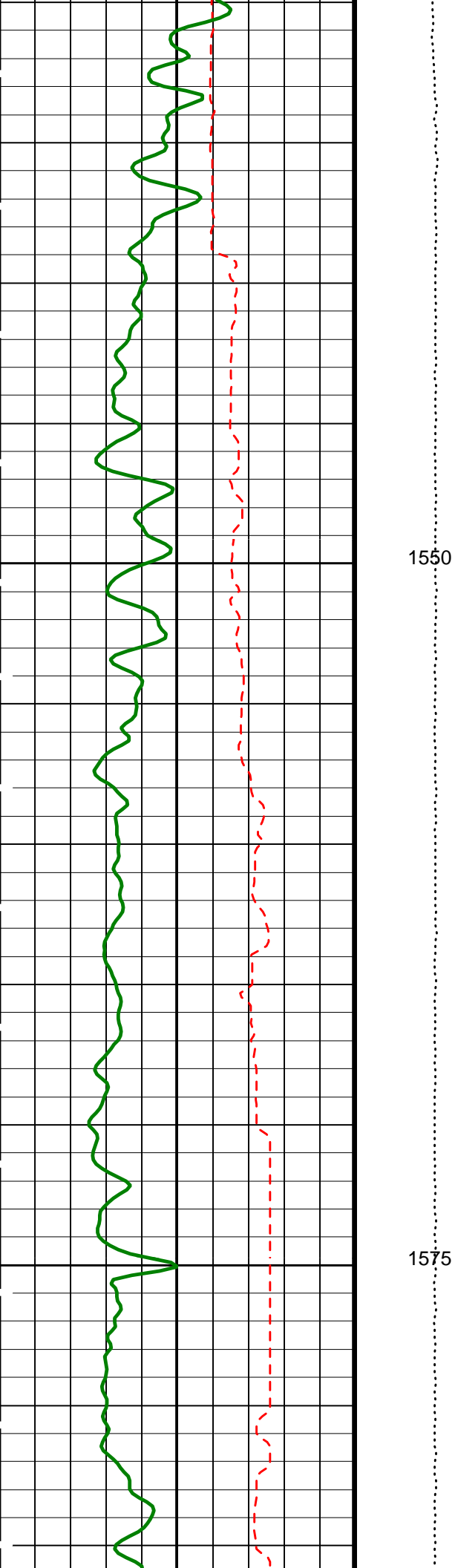

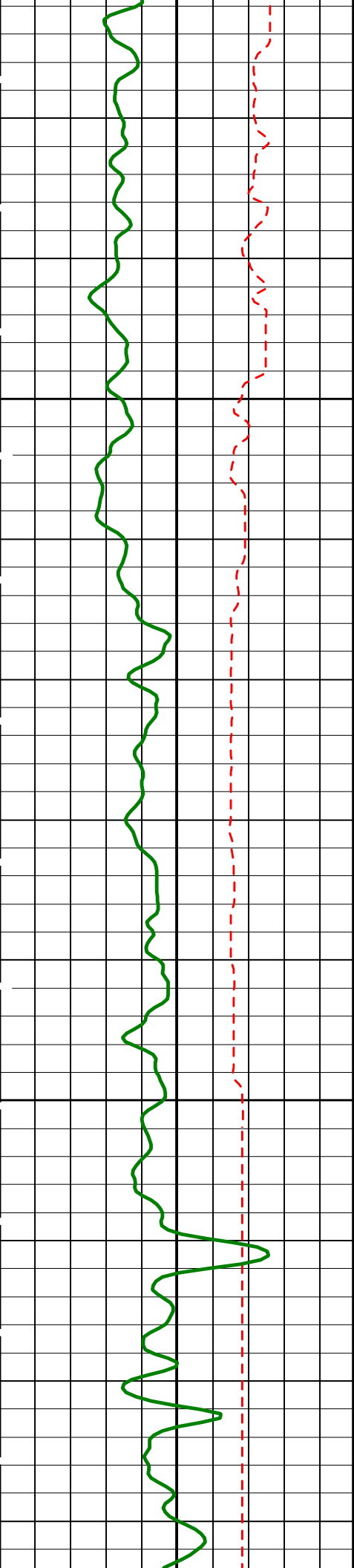

1600

1625



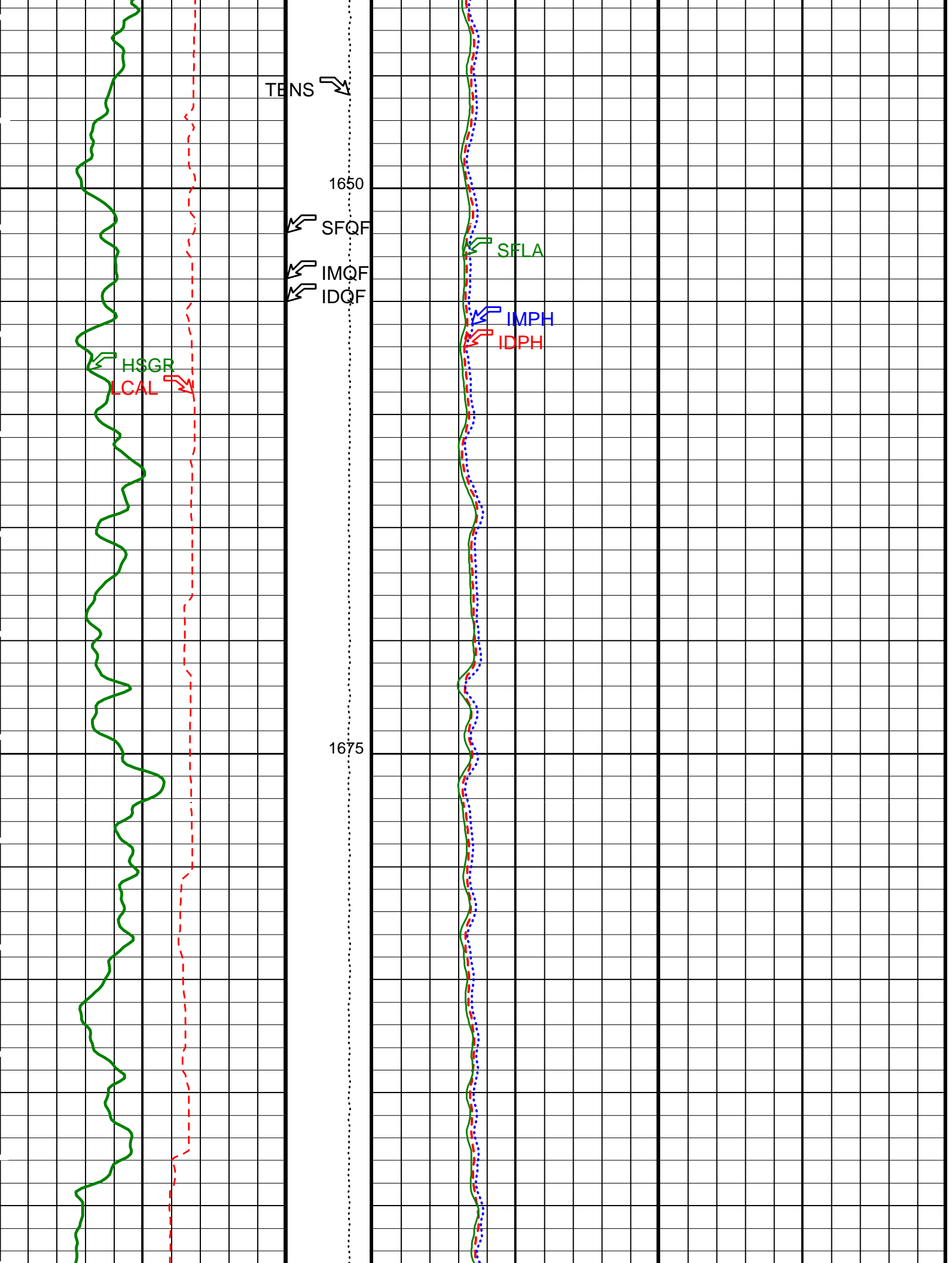

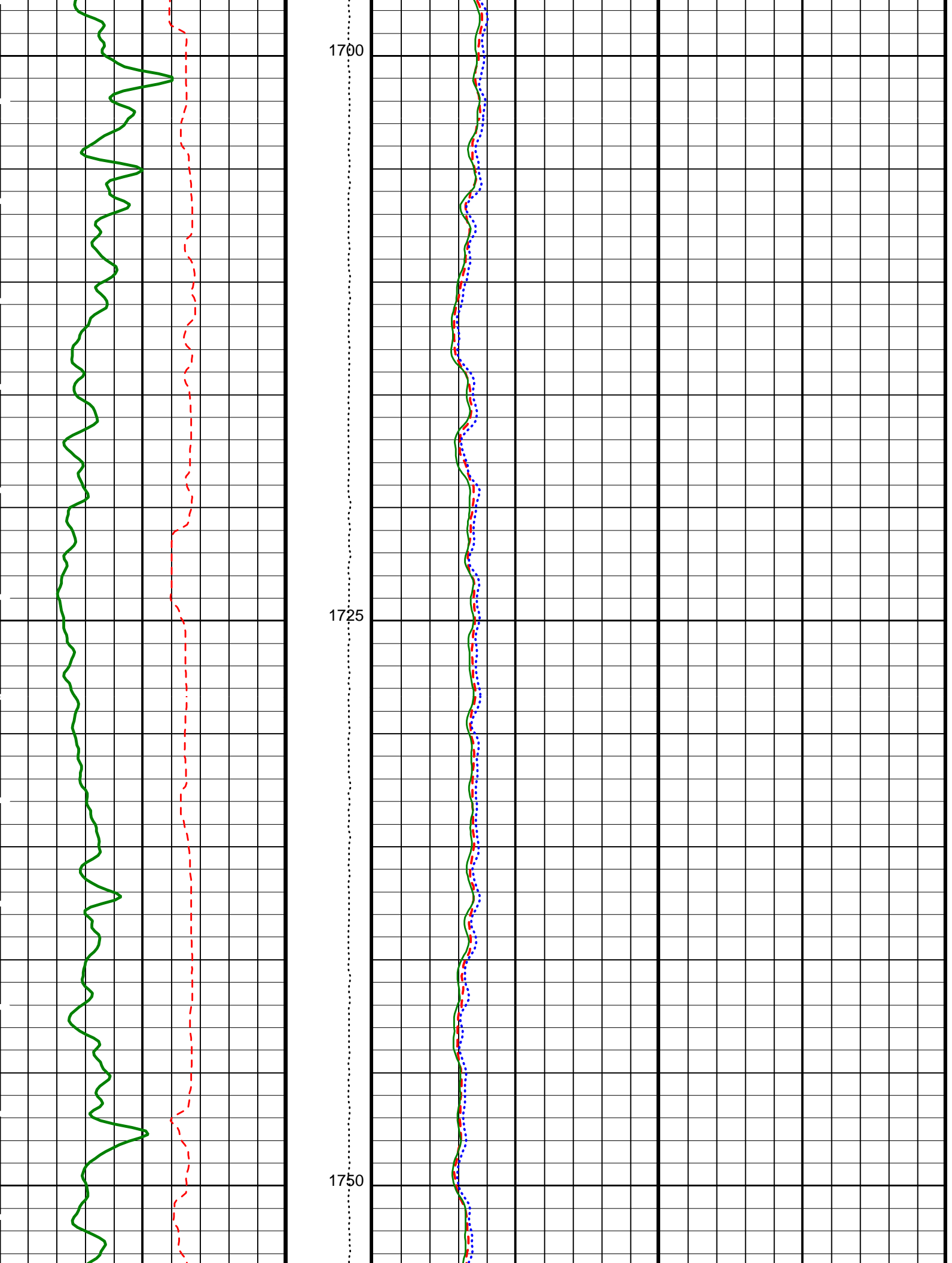

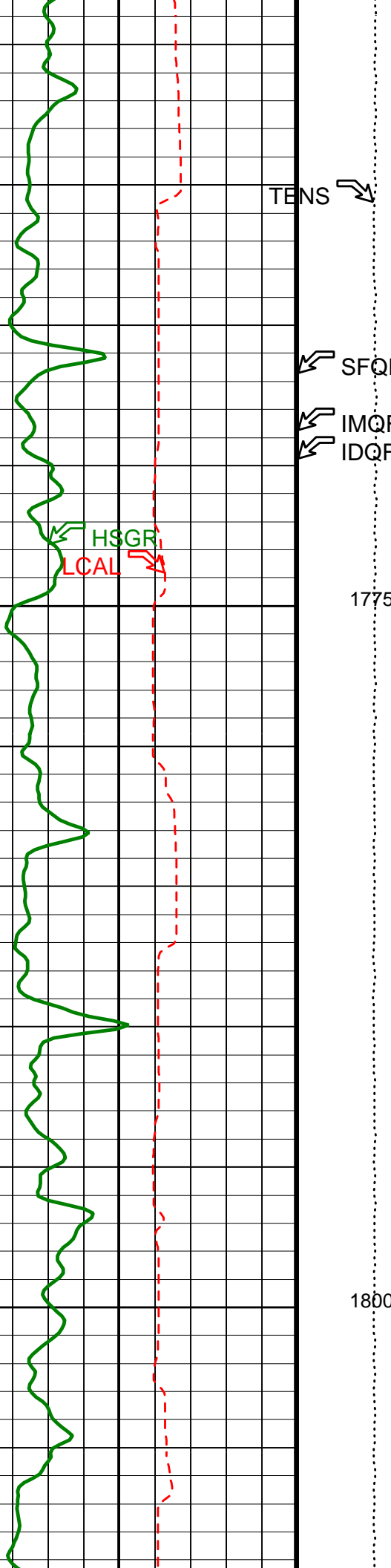

1775

1800

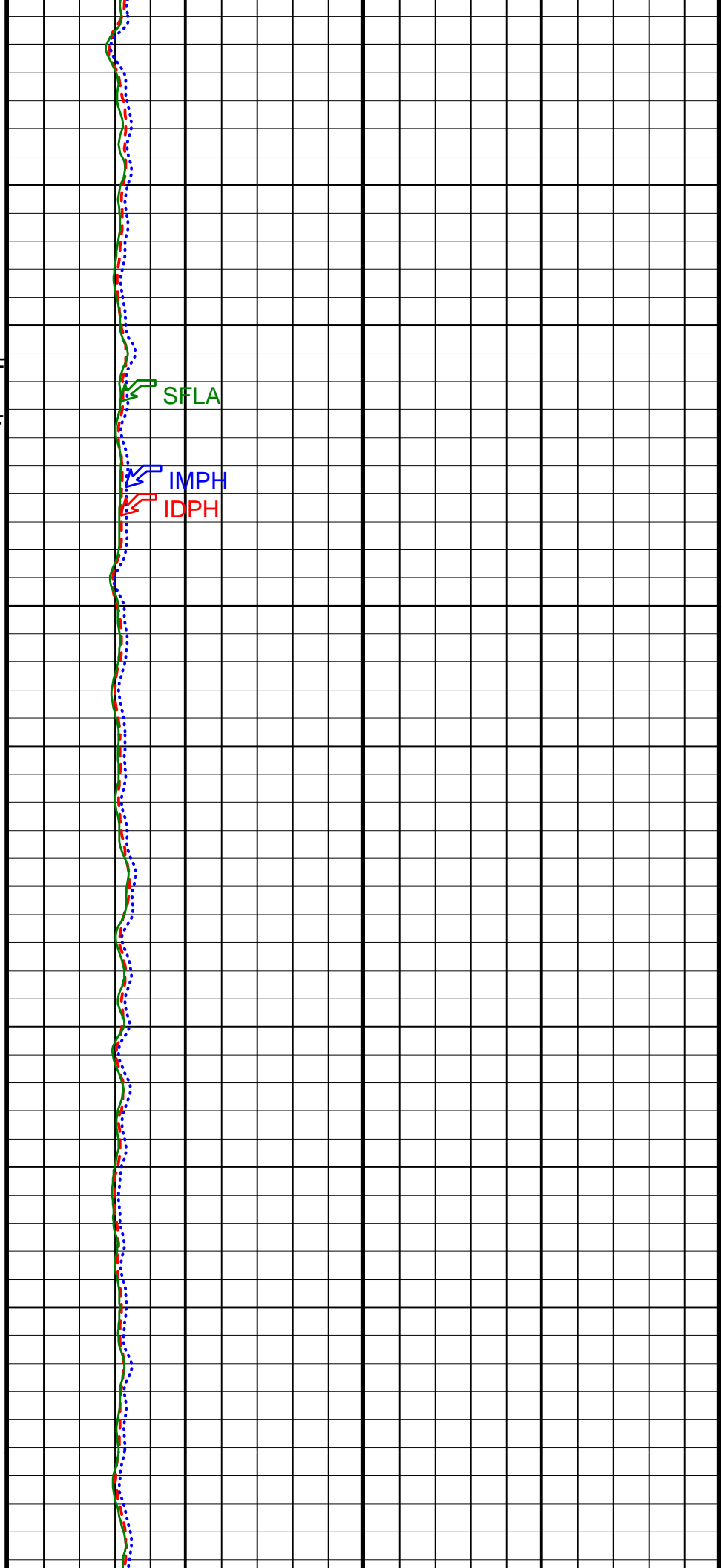

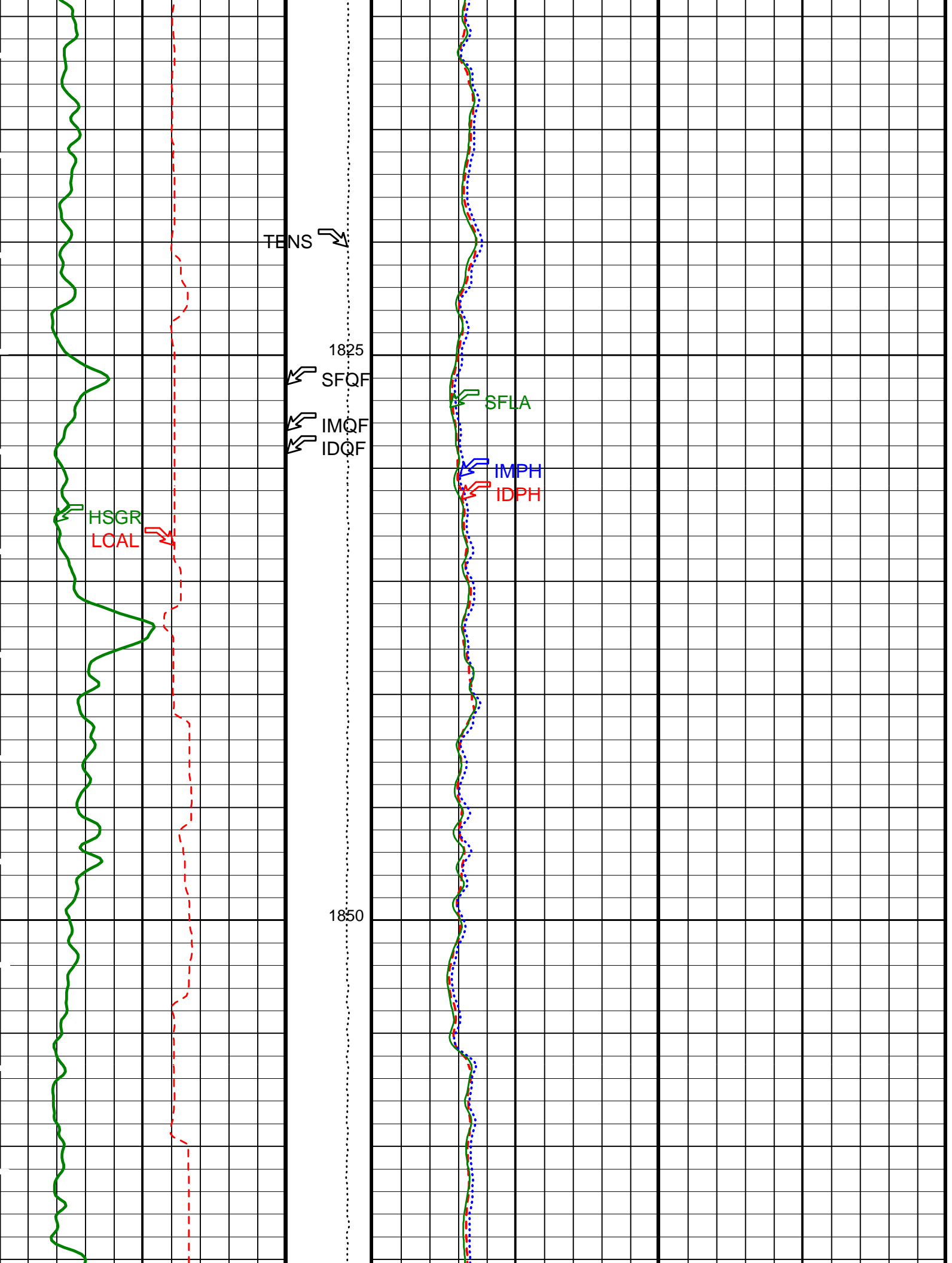

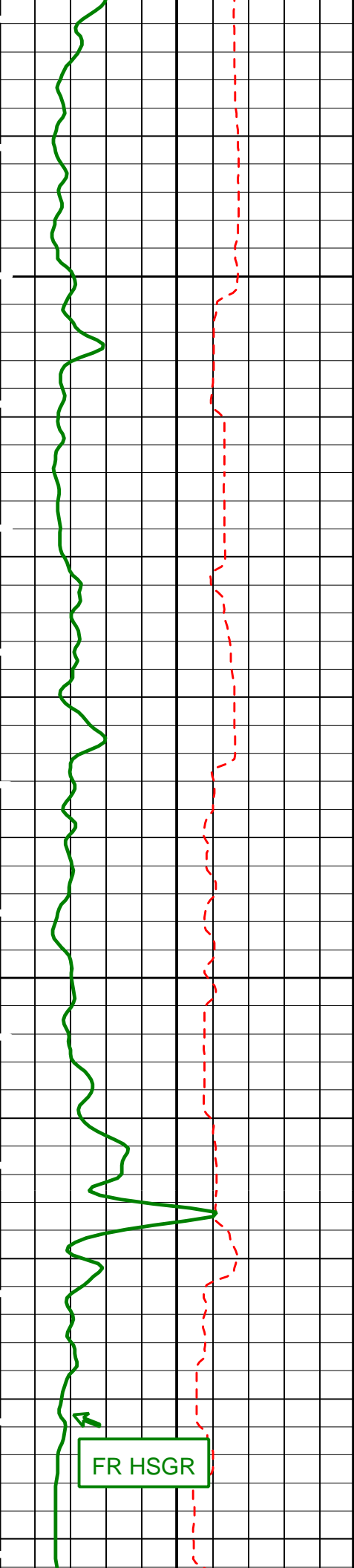

1875

1900

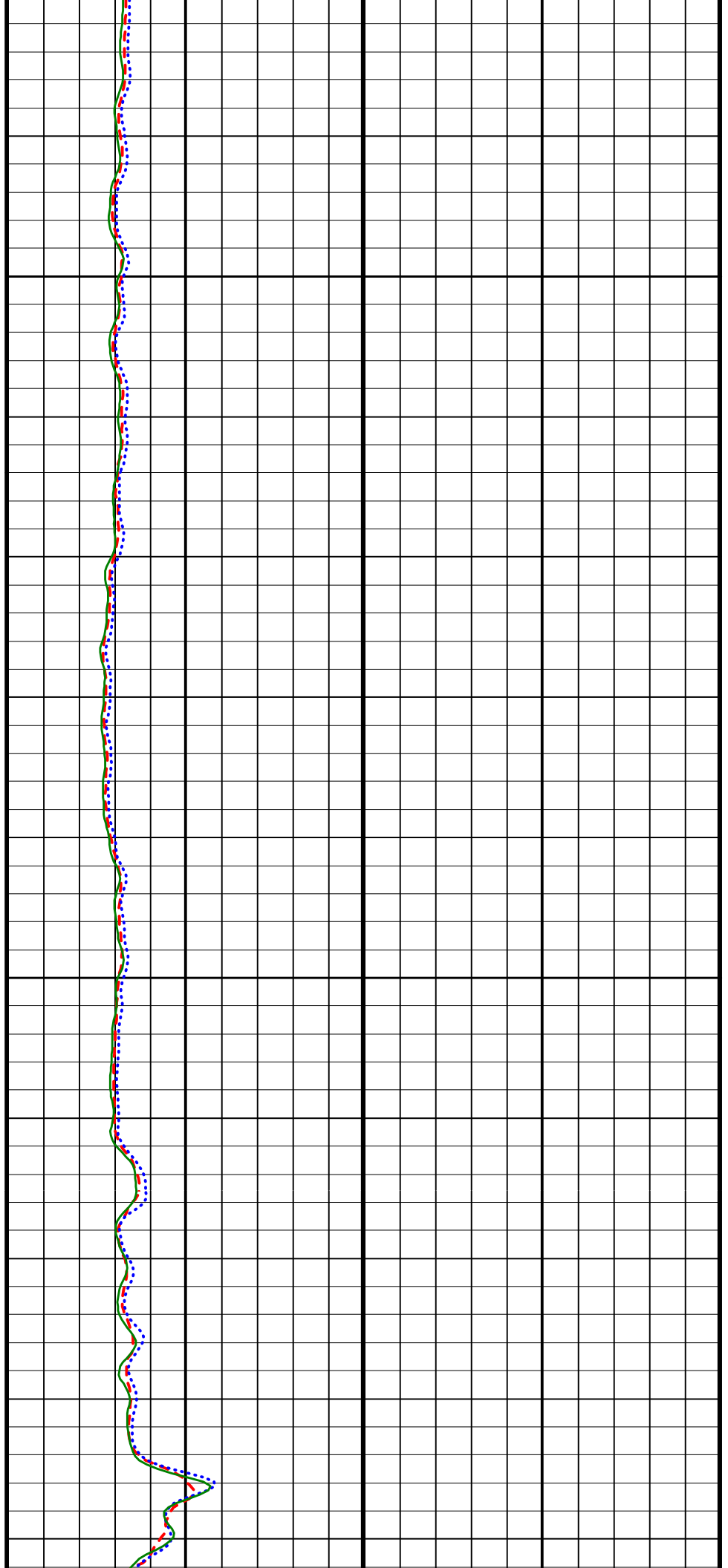

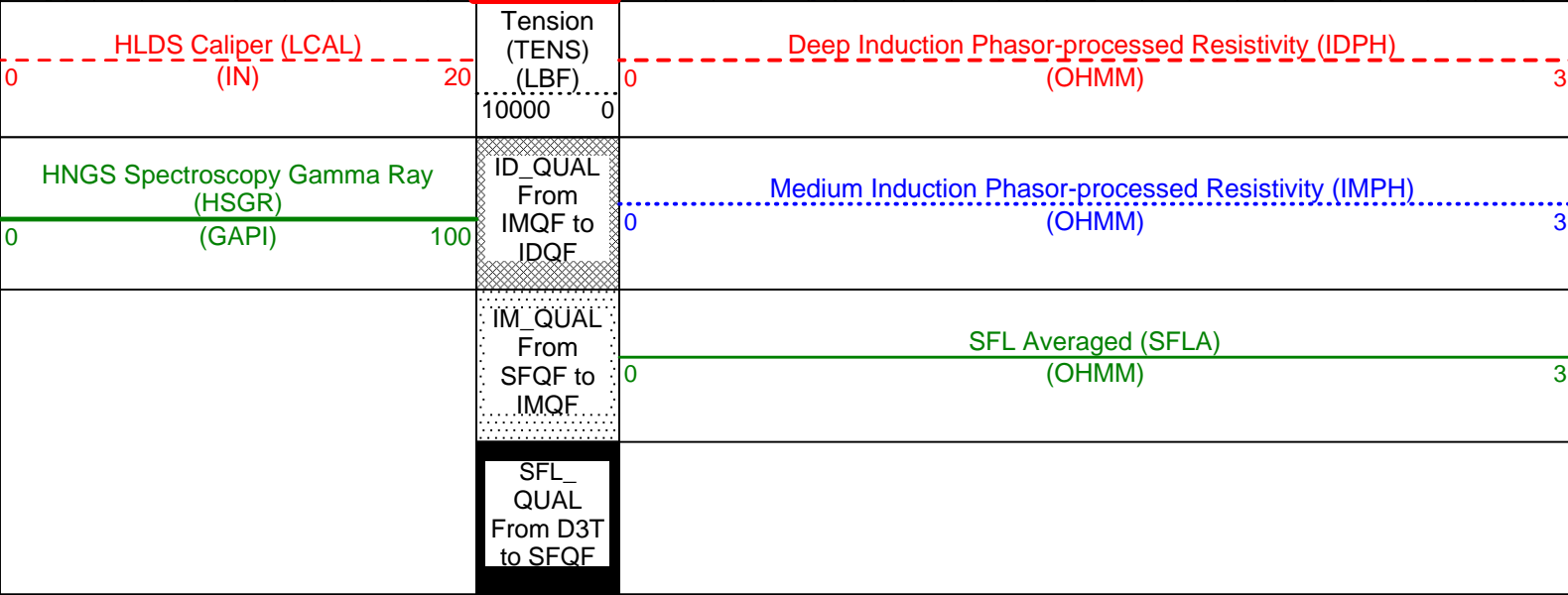
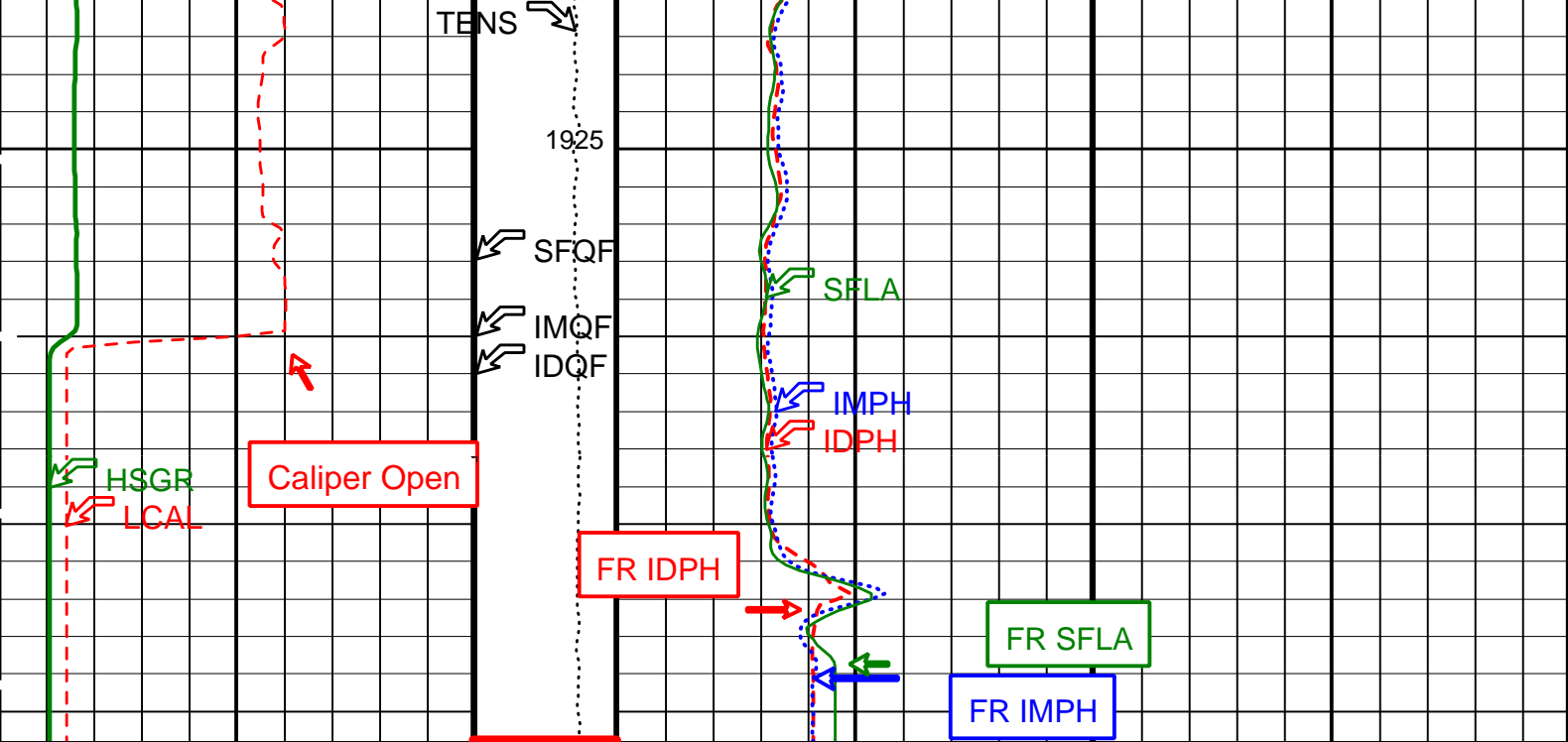

PIP SUMMARY

Time Mark Every 60 S

Parameters

DLIS Name	Description	Value	
DIT-E: Dual Induction - E			
BHS	Borehole Status	OPEN	
BHT	Bottom Hole Temperature (used in calculations)	40	DEGC
DGF2	Deep 20 kHz Gain Factor	1.00789	
DPH2	Deep 20 kHz Phase Shift	-0.152394	DEG
DRE2	Deep Real 20 kHz Sonde Error Correction	16.357	MM/M
DSR2	Deep Sigma Reference (20 kHz)	1843	MM/M
DXE2	Deep Quad 20 kHz Sonde Error Correction	64.6326	MM/M
GCSE	Generalized Caliper Selection	LCAL	
GDEV	Average Angular Deviation of Borehole from Normal	0	DEG
GGRD	Geothermal Gradient	0.018227	DC/M
GTSE	Generalized Temperature Selection	LINEAR_ESTIMATE	
IFRS	DIT-E Induction Frequency Selector	20	
IPHA	DIT-E Phasor Processing Mode	ALL	
IPRO	DIT-E Induction Processing Selector	PHASOR	
ITEN	DIT-E Temperature Enable	ENABLE	
MGF2	Medium 20 kHz Gain Factor	1.02964	
MPH2	Medium 20 kHz Phase Shift	-0.933067	DEG
MRE2	Medium Real 20 kHz Sonde Error Correction	-1.78642	MM/M
MSR2	Medium Sigma Reference (20 kHz)	3250	MM/M
MXE2	Medium Quad 20 kHz Sonde Error Correction	-34.2041	MM/M
SFCR	SFL Channel Ratio	1000	

SHT	Surface Hole Temperature	20	DEGC
APS-BA: Accelerator-Porosity Tool			
BHS	Borehole Status	OPEN	
BHT	Bottom Hole Temperature (used in calculations)	40	DEGC
GCSE	Generalized Caliper Selection	LCAL	
GDEV	Average Angular Deviation of Borehole from Normal	0	DEG
GGRD	Geothermal Gradient	0.018227	DC/M
GTSE	Generalized Temperature Selection	LINEAR_ESTIMATE	
SHT	Surface Hole Temperature	20	DEGC
HNGS-BA: Hostile Natural Gamma Ray Sonde			
BAR1	HNGS Detector 1 Barite Constant	1	
BAR2	HNGS Detector 2 Barite Constant	1	
BHK	HNGS Borehole Potassium Correction Concentration	0	
BHS	Borehole Status	OPEN	
BHT	Bottom Hole Temperature (used in calculations)	40	DEGC
CSD1	Inner Casing Outer Diameter	0	IN
CSD2	Outer Casing Outer Diameter	0	IN
CSW1	Inner Casing Weight	0	LB/F
CSW2	Outer Casing Weight	0	LB/F
DBCC	HNGS Barite Constant Correction Flag	NONE	
GCSE	Generalized Caliper Selection	LCAL	
GDEV	Average Angular Deviation of Borehole from Normal	0	DEG
GGRD	Geothermal Gradient	0.018227	DC/M
GTSE	Generalized Temperature Selection	LINEAR_ESTIMATE	
H1P	HNGS Detector 1 Allow/Disallow In Processing	ALLOW	
H2P	HNGS Detector 2 Allow/Disallow In Processing	ALLOW	
HABK	HNGS Borehole Potassium Running Average	-0.00298869	
HALF	HNGS Alpha Filter Length	60	IN
HCRB	HNGS Apply Borehole Potassium Correction	NONE	
HMWM	Mud Weighting Material	NATU	
HNPE	HNGS Processing Enable	YES	
S1BI	HNGS Detector 1 Calibration Bismuth Count Rate	1.3	CPS
S2BI	HNGS Detector 2 Calibration Bismuth Count Rate	1.3	CPS
SGRC	HNGS Standard Gamma-Ray Correction Flag	YES	
SHT	Surface Hole Temperature	20	DEGC
TPOS	Tool Position	ECCE	
VBA1	HNGS Detector 1 Variable Barite Factor Running Average	0.981098	
VBA2	HNGS Detector 2 Variable Barite Factor Running Average	1.0123	
System and Miscellaneous			
BS	Bit Size	11.437	IN
DFD	Drilling Fluid Density	1.07	G/C3
TD	Total Depth	1953	M

Format: DITE_LinPhasor_1 Vertical Scale: 1:200 Graphics File Created: 12-May-2002 17:59

OP System Version: 10C0-306

MCM

DIT-E	10C0-306	DTA-A	10C0-306
HLDS	10C0-306	NPLC-B	10C0-306
APS-BA	10C0-306	HNGS-BA	10C0-306
DTC-H	10C0-306		

Output DLIS Files

DEFAULT	PI_LDL_APS_NGS_007LUP	FN:8	PRODUCER	12-May-2002 17:59
TCOMBO_CSUT	PI_LDL_APS_NGS_007LUP	FN:9	PRODUCER	12-May-2002 17:59

Calibration and Check Summary

Measurement	Nominal	Master	Before	After	Change	Limit	Units
Hostile Litho-Density Sonde Wellsite Calibration - Caliper Calibration							
Before: 5-Apr-2002 16:30							
HLDS Caliper Small Ring	12.00	N/A	16.46	N/A	N/A	N/A	IN
HLDS Caliper Large Ring	15.00	N/A	20.85	N/A	N/A	N/A	IN
Accelerator-Porosity Tool Wellsite Calibration - Detector Background							
Master: 21-Mar-2002 2:06 Before: 21-Mar-2002 1:16 After: 13-May-2002 2:07							
Near Det Bkg Cntrate	30.00	31.79	31.97	32.28	0.3159	N/A	CPS
Far Det Bkg Cntrate	30.00	33.36	31.41	34.42	3.011	N/A	CPS
Array-1 Det Bkg Cntrate	30.00	29.50	29.21	28.98	-0.2376	N/A	CPS
Array-2 Det Bkg Cntrate	30.00	30.45	30.38	29.49	-0.8903	N/A	CPS
Array Therm Det Bkg Cntrate	30.00	30.62	31.95	29.60	-2.346	N/A	CPS

Accelerator-Porosity Tool Wellsite Calibration - Calibration Ratios

Master: 21-Mar-2002 2:07

Near/Far Calibration Ratio	0.9250	0.8989	N/A	N/A	N/A	N/A
Near/Array Calibration Ratio	1.030	1.064	N/A	N/A	N/A	N/A
Near/Array Cal Ratio Up/Down	1.000	1.007	N/A	N/A	N/A	N/A

Accelerator-Porosity Tool Wellsite Calibration - Tank Check

Master: 21-Mar-2002 2:07

Array-1 Standoff Porosity	11.10	12.15	N/A	N/A	N/A	N/A	PU
Array-2 Standoff Porosity	11.10	11.15	N/A	N/A	N/A	N/A	PU
Average Slowing Down Time	6.000	5.886	N/A	N/A	N/A	N/A	US
Array-1 SDT Ratio Up/Down	1.000	1.013	N/A	N/A	N/A	N/A	
Array-1 SDT Ratio Up/Down	1.000	0.9940	N/A	N/A	N/A	N/A	
Sigma Formation	27.50	27.91	N/A	N/A	N/A	N/A	CU

Hostile Natural Gamma Ray Sonde Wellsite Calibration - Detector 1 Check

Master: 21-Mar-2002 20:49 Before: 8-Apr-2002 6:53 After: 13-May-2002 2:09

Na 511 Peak Loc	40.00	40.59	40.59	40.65	0.05537	1.000	
Na 511 Peak Res	15.50	16.49	16.15	16.28	0.1238	2.000	%
High Voltage	1150	1203	1204	1209	4.737	30.00	V
Na 1785 Peak Loc	142.6	145.3	144.7	145.6	0.8562	7.000	
Na 1785 Peak Res	8.500	8.834	9.406	9.123	-0.2832	2.000	%
Temperature	15.50	32.64	19.52	28.28	8.766	N/A	DEGC
Na Count Rate	45.00	39.13	38.65	36.58	-2.067	8.000	CPS

Hostile Natural Gamma Ray Sonde Wellsite Calibration - Detector 2 Check

Master: 21-Mar-2002 20:49 Before: 8-Apr-2002 6:53 After: 13-May-2002 2:09

Na 511 Peak Loc	40.00	40.47	40.56	40.65	0.08958	1.000	
Na 511 Peak Res	15.50	17.44	15.92	16.73	0.8062	2.000	%
High Voltage	1150	1234	1235	1240	4.652	30.00	V
Na 1785 Peak Loc	142.6	144.3	144.0	144.7	0.7126	7.000	
Na 1785 Peak Res	8.500	9.730	9.069	10.38	1.314	2.000	%
Temperature	15.50	32.65	18.79	28.38	9.587	N/A	DEGC
Na Count Rate	45.00	38.71	38.55	36.17	-2.387	8.000	CPS

Hostile Natural Gamma Ray Sonde Wellsite Calibration - Ratio Of Detector 1 To Detector 2

Master: 21-Mar-2002 20:49 Before: 8-Apr-2002 6:53 After: 13-May-2002 2:09

Coincidence Count Rate Ratio	1.000	1.013	1.004	1.008	0.004236	0.05000
------------------------------	-------	-------	-------	-------	----------	---------

Accelerator-Porosity Tool - Detector Plateau Settings :

Near Detector Plateau Setting	1748 V
Far Detector Plateau Setting	2052 V
Array Detector Plateau Setting	1969 V

Dual Induction - E / Equipment Identification

Primary Equipment:

Dual Induction Sonde	DIS - HB	442
Dual Induction Cartridge	DIC - EB	438

Auxiliary Equipment:

Mass Isolated Housing	MIH - ZA	417
-----------------------	----------	-----

Dual Induction - E Wellsite Calibration

Electronics Calibration Changes Files/Depth Intervals:

Phase	ID (R > 27 OHM-M) MM/M	Value	Phase	ID (R < 27 OHM-M) %	Value	Phase	SFL (R < 1 OHM-M) OHMM	Value
After		0	After		0.0001520	After		0.0004569
	0 (Minimum) 0 (Nominal) 0.7500 (Maximum)			0 (Minimum) 0 (Nominal) 2.000 (Maximum)			0 (Minimum) 0 (Nominal) 0.02000 (Maximum)	
Phase	IM (R > 27 OHM-M) MM/M	Value	Phase	IM (R < 27 OHM-M) %	Value			
After		0	After		0.0001305			
	0 (Minimum) 0 (Nominal) 0.7500 (Maximum)			0 (Minimum) 0 (Nominal) 2.000 (Maximum)				
Phase	SFL (R > 27 OHM-M) MM/M	Value	Phase	SFL (R < 27 OHM-M) %	Value			
After		0	After		0.0004866			
	0 (Minimum) 0 (Nominal) 0.7500 (Maximum)			0 (Minimum) 0 (Nominal) 2.000 (Maximum)				

After: 12-May-2002 22:00

Hostile Litho-Density Sonde / Equipment Identification

Primary Equipment:

Hostile Litho Density Sonde	HLDS - D	35
Hostile Litho Density High Voltage	HLDV - D	35
Gamma Source Radioactive	GSR - Z	1846

Auxiliary Equipment:

Hostile Litho Density Pad	HLDP - C	35
Hostile Litho Density High Voltage Housi	HEH - H	35

Nuclear Porosity Lithology Cartridge - B / Equipment Identification

Primary Equipment:

NPLC Cartridge	NPLC - B	79
----------------	----------	----

Auxiliary Equipment:

NPLC Housing	NPH - B	82
--------------	---------	----

Accelerator-Porosity Tool / Equipment Identification

Primary Equipment:

Accelerator-Porosity Sonde	APS - BA	22
APS Minitron	MNTR - F	4185

Auxiliary Equipment:

Accelerator-Porosity Housing	APH - AC	22
APS Calibration Water Tank	SFT - 178	4722
APS Aluminium Calibrator Sleeve	SFT - 281	24

Accelerator-Porosity Tool Wellsite Calibration

Detector Background

Phase	Near Det Bkg Cntrate CPS	Value	Phase	Far Det Bkg Cntrate CPS	Value	Phase	Array-1 Det Bkg Cntrate CPS	Value
Master		31.79	Master		33.36	Master		29.50
Before		31.97	Before		31.41	Before		29.21
After		32.28	After		34.42	After		28.98
	0 (Minimum) 30.00 (Nominal) 50.00 (Maximum)			0 (Minimum) 30.00 (Nominal) 50.00 (Maximum)			0 (Minimum) 30.00 (Nominal) 50.00 (Maximum)	
Phase	Array-2 Det Bkg Cntrate CPS	Value	Phase	Array Therm Det Bkg Cntrate CPS	Value			
Master		30.45	Master		30.62			
Before		30.38	Before		31.95			
After		29.49	After		29.60			
	0 (Minimum) 30.00 (Nominal) 50.00 (Maximum)			0 (Minimum) 30.00 (Nominal) 50.00 (Maximum)				
Master: 21-Mar-2002 2:06			Before: 21-Mar-2002 1:16			After: 13-May-2002 2:07		

Accelerator-Porosity Tool Wellsite Calibration

Calibration Ratios

Phase	Near/Far Calibration Ratio	Value	Phase	Near/Array Calibration Ratio	Value	Phase	Near/Array Cal Ratio Up/Down	Value
Master		0.8989	Master		1.064	Master		1.007
	0.8000 (Minimum) 0.9250 (Nominal) 1.050 (Maximum)			0.9000 (Minimum) 1.030 (Nominal) 1.170 (Maximum)			0.9700 (Minimum) 1.000 (Nominal) 1.030 (Maximum)	
Master: 21-Mar-2002 2:07								

Accelerator-Porosity Tool Wellsite Calibration

Tank Check

Phase	Array-1 Standoff Porosity PU	Value	Phase	Array-2 Standoff Porosity PU	Value	Phase	Average Slowing Down Time US	Value
Master		12.15	Master		11.15	Master		5.886
	9.900 (Minimum) 11.10 (Nominal) 12.30 (Maximum)			9.900 (Minimum) 11.10 (Nominal) 12.30 (Maximum)			5.750 (Minimum) 6.000 (Nominal) 6.250 (Maximum)	
Phase	Array-1 SDT Ratio Up/Down	Value	Phase	Array-1 SDT Ratio Up/Down	Value	Phase	Sigma Formation CU	Value
Master		1.013	Master		0.9940	Master		27.91
	0.9500 (Minimum) 1.000 (Nominal) 1.050 (Maximum)			0.9500 (Minimum) 1.000 (Nominal) 1.050 (Maximum)			20.00 (Minimum) 27.50 (Nominal) 35.00 (Maximum)	

Hostile Natural Gamma Ray Sonde / Equipment Identification



Primary Equipment:
 HNGS Sonde HNGS - BA 77

Auxiliary Equipment:
 HNGS Sonde Housing HNSH - BA 79
 Gamma Source Radioactive GSR - U 135

Hostile Natural Gamma Ray Sonde Wellsite Calibration									
Detector 1 Check									
Phase	Na 511 Peak Loc	Value	Phase	Na 511 Peak Res %	Value	Phase	High Voltage V	Value	
Master		40.59	Master		16.49	Master		1203	
Before		40.59	Before		16.15	Before		1204	
After		40.65	After		16.28	After		1209	
	37.50 (Minimum) 40.00 (Nominal) 42.50 (Maximum)			12.00 (Minimum) 15.50 (Nominal) 19.00 (Maximum)			900.0 (Minimum) 1150 (Nominal) 1600 (Maximum)		
Phase	Na 1785 Peak Loc	Value	Phase	Na 1785 Peak Res %	Value	Phase	Temperature DEGC	Value	
Master		145.3	Master		8.834	Master		32.64	
Before		144.7	Before		9.406	Before		19.52	
After		145.6	After		9.123	After		28.28	
	135.0 (Minimum) 142.6 (Nominal) 150.3 (Maximum)			7.000 (Minimum) 8.500 (Nominal) 11.00 (Maximum)			-28.89 (Minimum) 15.50 (Nominal) 60.00 (Maximum)		
Phase	Na Count Rate CPS	Value							
Master		39.13							
Before		38.65							
After		36.58							
	15.00 (Minimum) 45.00 (Nominal) 100.0 (Maximum)								
Master: 21-Mar-2002 20:49			Before: 8-Apr-2002 6:53			After: 13-May-2002 2:09			

Hostile Natural Gamma Ray Sonde Wellsite Calibration									
Detector 2 Check									
Phase	Na 511 Peak Loc	Value	Phase	Na 511 Peak Res %	Value	Phase	High Voltage V	Value	
Master		40.47	Master		17.44	Master		1234	
Before		40.56	Before		15.92	Before		1235	
After		40.65	After		16.73	After		1240	
	37.50 (Minimum) 40.00 (Nominal) 42.50 (Maximum)			12.00 (Minimum) 15.50 (Nominal) 19.00 (Maximum)			900.0 (Minimum) 1150 (Nominal) 1600 (Maximum)		
Phase	Na 1785 Peak Loc	Value	Phase	Na 1785 Peak Res %	Value	Phase	Temperature DEGC	Value	
Master		144.3	Master		9.730	Master		32.65	
Before		144.0	Before		9.069	Before		18.79	
After		144.7	After		10.38	After		28.38	
	135.0 (Minimum) 142.6 (Nominal) 150.3 (Maximum)			7.000 (Minimum) 8.500 (Nominal) 11.00 (Maximum)			-28.89 (Minimum) 15.50 (Nominal) 60.00 (Maximum)		
Phase	Na Count Rate CPS	Value							
Master		38.71							
Before		38.55							
After		36.17							
	15.00 (Minimum) 45.00 (Nominal) 100.0 (Maximum)								
Master: 21-Mar-2002 20:49			Before: 8-Apr-2002 6:53			After: 13-May-2002 2:09			

Hostile Natural Gamma Ray Sonde Wellsite Calibration		
Ratio Of Detector 1 To Detector 2		
Phase	Coincidence Count Rate Ratio	Value

Master		1.013	
Before		1.004	
After		1.008	
	0.9500 (Minimum)	1.000 (Nominal)	1.050 (Maximum)
Master: 21-Mar-2002 20:49			
Before: 8-Apr-2002 6:53			
After: 13-May-2002 2:09			

Company: Lamont Doherty

Schlumberger

Well: ODP Leg 202, Site 1239A

Field: Carnegie Ridge

Country: Ecuador

Ocean: Pacific Ocean

Phasor Induction- Natural Gamma Ray