

**Company:** Lamont Doherty

**Well:** ODP Leg 207 Site 1258C

**Field:** Demarara Rise

**Country:** Venezuela

**Ocean:** Atlantic

## Phasor Induction Natural Gamma Ray

Country: Venezuela		Elev.: K.B. 11.3 m	
Field: Demarara Rise		G.L. -3203 m	
Location: 9.433 Deg North, 54.7327 Deg V		D.F. 11 m	
Well: ODP Leg 207 Site 1258C		Elev.: 0 m	
Company: Lamont Doherty		11.3 m above Perm. Datum	
LOCATION			
Permanent Datum: _____		MSL _____	
Log Measured From: _____		DES _____	
Drilling Measured From: _____		DES _____	
API Serial No. _____		Max. Hole Devi. _____	Longitude _____
			Latitude _____

Logging Date	31-Jan-2003	
Run Number	1	
Depth Driller	3688 m	
Schlumberger Depth	3683 m	
Bottom Log Interval	3677 m	
Top Log Interval	3194 m	
Casing Driller Size @ Depth	0.000 in @ 3283 m	
Casing Schlumberger	3281 m	
Bit Size	9.875 in	
Type Fluid In Hole	Sepolite Salt Water	
Density	1.1 g/cm3	
Fluid Loss	PH _____	
Source Of Sample	Mudpit	
RM @ Measured Temperature	0.258 ohm.m @ 32 degC	
RMF @ Measured Temperature	@ @	
RMC @ Measured Temperature	@ @	
Source RMF	RMC	
RM @ MRT	0.383 @ 15 @ 15	
Maximum Recorded Temperatures	15 degC	
Circulation Stopped	Time _____	
Logger On Bottom	31-Jan-2003 Time 07:13	
Unit Number	99 Location Houston, TX ODP	
Recorded By	K. Swain	
Witnessed By	B. Rea, F. Heidersdorf	

Logging Date	Run 1	Run 2	Run
Run Number			
Depth Driller			
Schlumberger Depth			
Bottom Log Interval			
Top Log Interval			
Casing Driller Size @ Depth			
Casing Schlumberger			
Bit Size			
Type Fluid In Hole			
Density			
Fluid Loss			
Source Of Sample			
RM @ Measured Temperature			
RMF @ Measured Temperature			
RMC @ Measured Temperature			
Source RMF			
RM @ MRT			
Maximum Recorded Temperatures			
Circulation Stopped			
Logger On Bottom			
Unit Number			
Recorded By			
Witnessed By			

**DISCLAIMER**

THE USE OF AND RELIANCE UPON THIS RECORDED-DATA BY THE HEREIN NAMED COMPANY (AND ANY OF ITS AFFILIATES, PARTNERS, REPRESENTATIVES, AGENTS, CONSULTANTS AND EMPLOYEES) IS SUBJECT TO THE TERMS AND CONDITIONS AGREED UPON BETWEEN SCHLUMBERGER AND THE COMPANY, INCLUDING: (a) RESTRICTIONS ON USE OF THE RECORDED-DATA; (b) DISCLAIMERS AND WAIVERS OF WARRANTIES AND REPRESENTATIONS REGARDING COMPANY'S USE OF AND RELIANCE UPON THE RECORDED-DATA; AND (c) CUSTOMER'S FULL AND SOLE RESPONSIBILITY FOR ANY INFERENCE DRAWN OR DECISION MADE IN CONNECTION WITH THE USE OF THIS RECORDED-DATA.

**OTHER SERVICES1**  
 OS1: FMS/LSS  
 OS2: HLDS/APS/DITE  
 OS3:  
 OS4:  
 OS5:

**OTHER SERVICES2**  
 OS1:  
 OS2:  
 OS3:  
 OS4:  
 OS5:

**REMARKS: RUN NUMBER 1**  
 Hole cored with RCB, 9 7/8 bit.  
 Driller Sea Floor at:3203 mbrf.  
 Log measured in meters below rig floor.  
 Lamont TAP tool run at bottom of DITE for temperature/pressure data.  
 Wireline heave compensator used on all runs.  
 Sepiolite mud was used to displace the hole.  
 Driller TD= 3688 mbrf.  
 Schlumberger TD= 3683 mbrf.  
 Drill pipe Schlumberger= 3281 mbrf.

**REMARKS: RUN NUMBER 2**

**RUN 1**  
 SERVICE ORDER #:  
 PROGRAM VERSION: 10C0-306  
 FLUID LEVEL:

**RUN 2**  
 SERVICE ORDER #:  
 PROGRAM VERSION:  
 FLUID LEVEL:

LOGGED INTERVAL	START	STOP



LOGGED INTERVAL	START	STOP

**EQUIPMENT DESCRIPTION**

**RUN 1**  
**SURFACE EQUIPMENT**  
 SFT-281 24  
 SFT-178 4722  
 GSR-U 135  
 WITM (DTS)-A

**RUN 2**

**DOWNHOLE EQUIPMENT**

LEH-QT		37.04
LEH-QT 1497		
AH-MGT		36.15
AH-MGT		

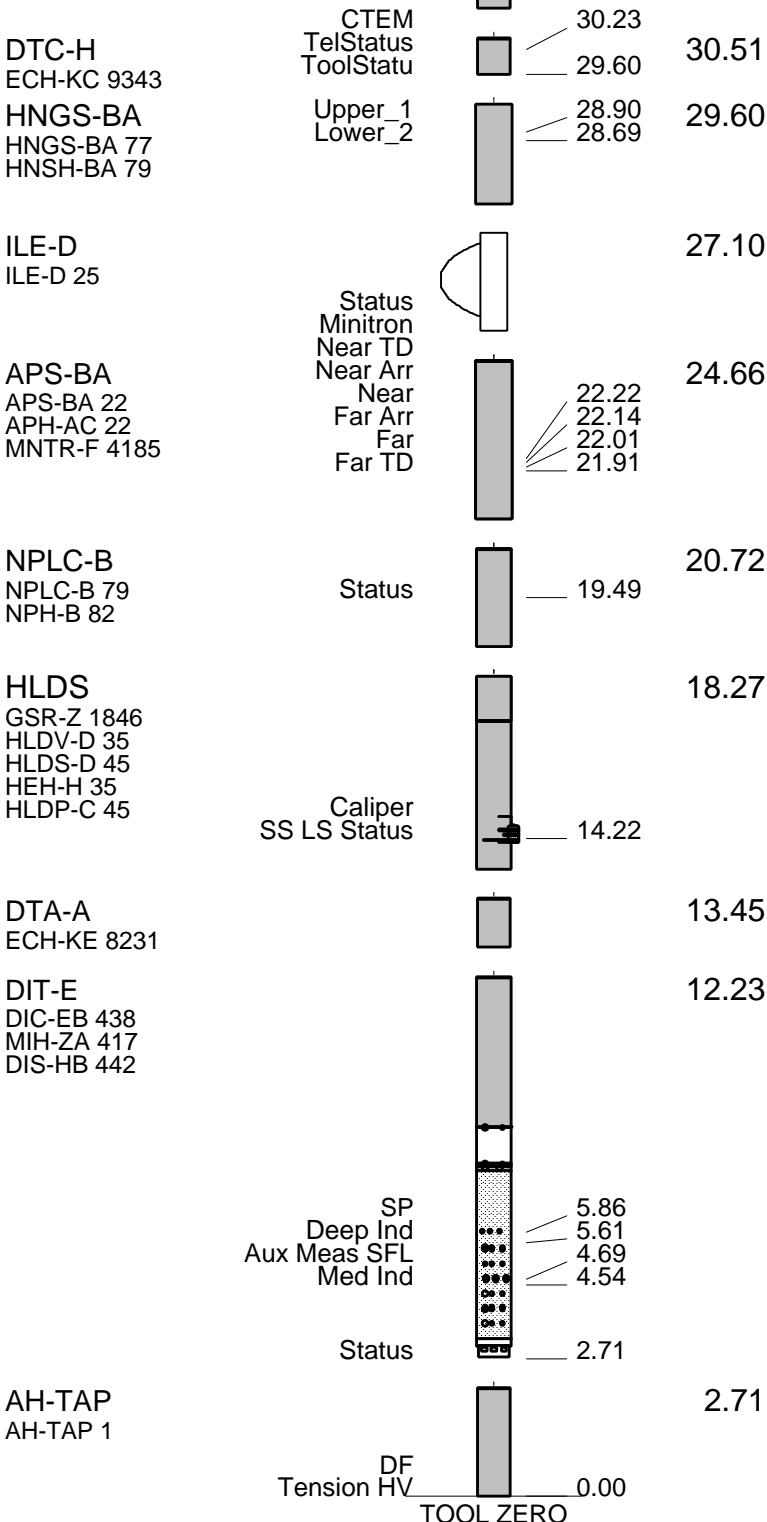

MAXIMUM STRING DIAMETER 3.88 IN  
 MEASUREMENTS RELATIVE TO TOOL ZERO  
 ALL LENGTHS IN METERS

## Output DLIS Files

DEFAULT	PI_LDL_APS_NGS_005LUP	FN:6	PRODUCER	31-Jan-2003 07:13	3685.0 M	3164.4 M
REDUCE	PI_LDL_APS_NGS_005LUP	FN:7	PRODUCER	31-Jan-2003 07:13	3685.0 M	3164.4 M

## OP System Version: 10C0-306

MCM

DIT-E	10C0-306	DTA-A	10C0-306
HLDS	SPC-2277-NUCL_b	NPLC-B	OP10-KP1
APS-BA	SPC-2277-NUCL_b	HNGS-BA	SPC-2277-NUCL_b
DTC-H	10C0-306		

### PIP SUMMARY

Time Mark Every 60 S

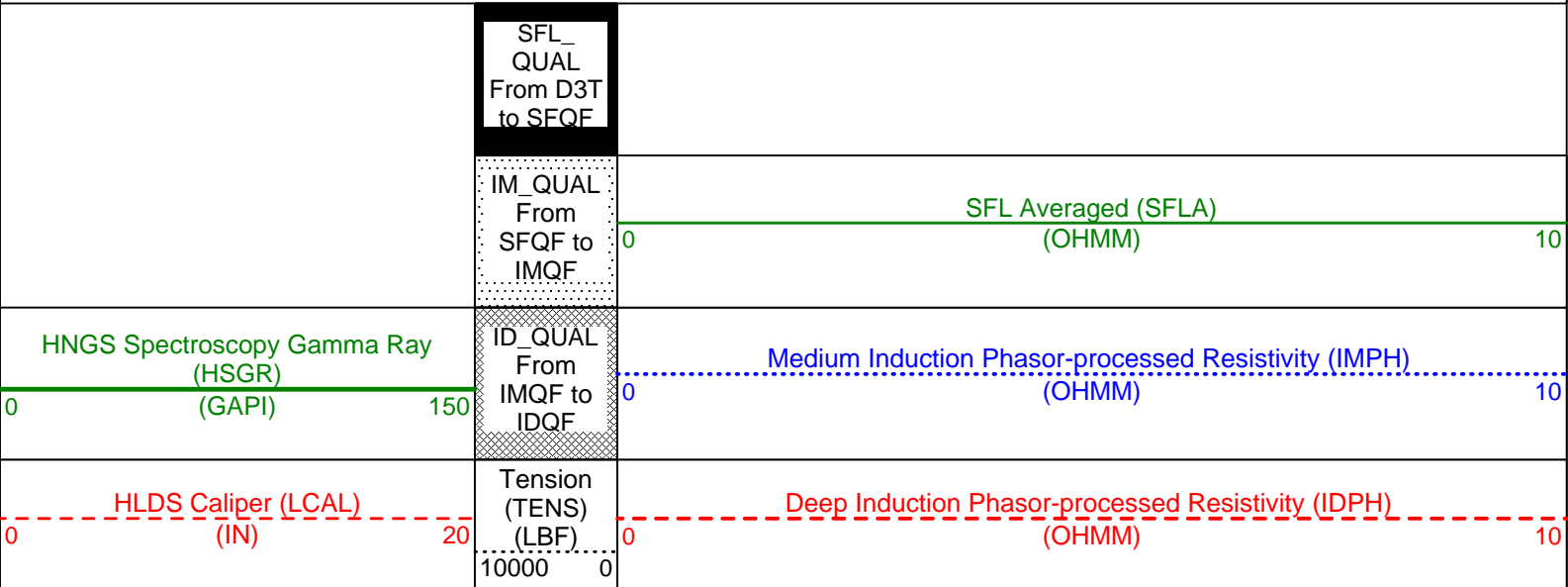

Main Log

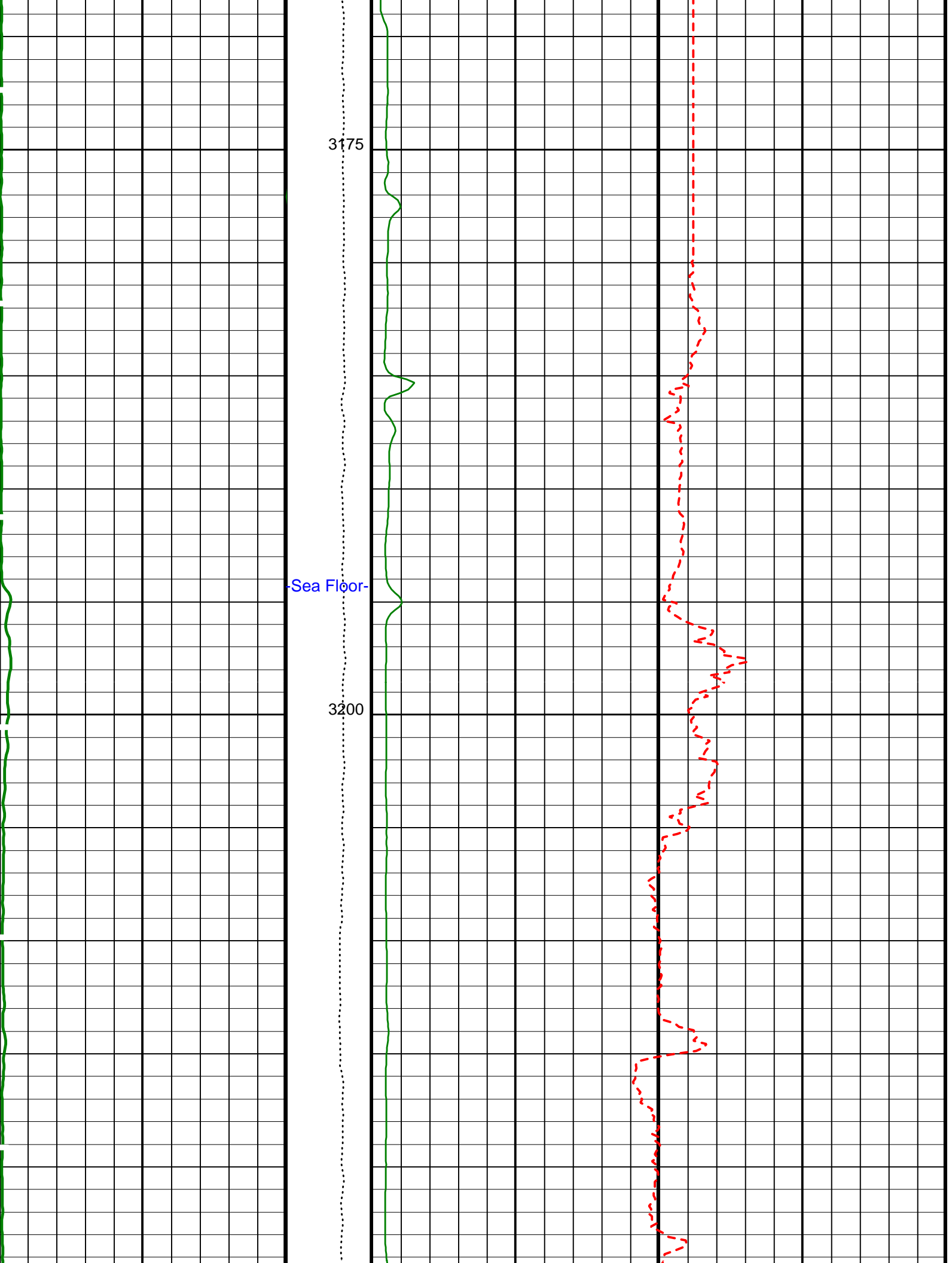



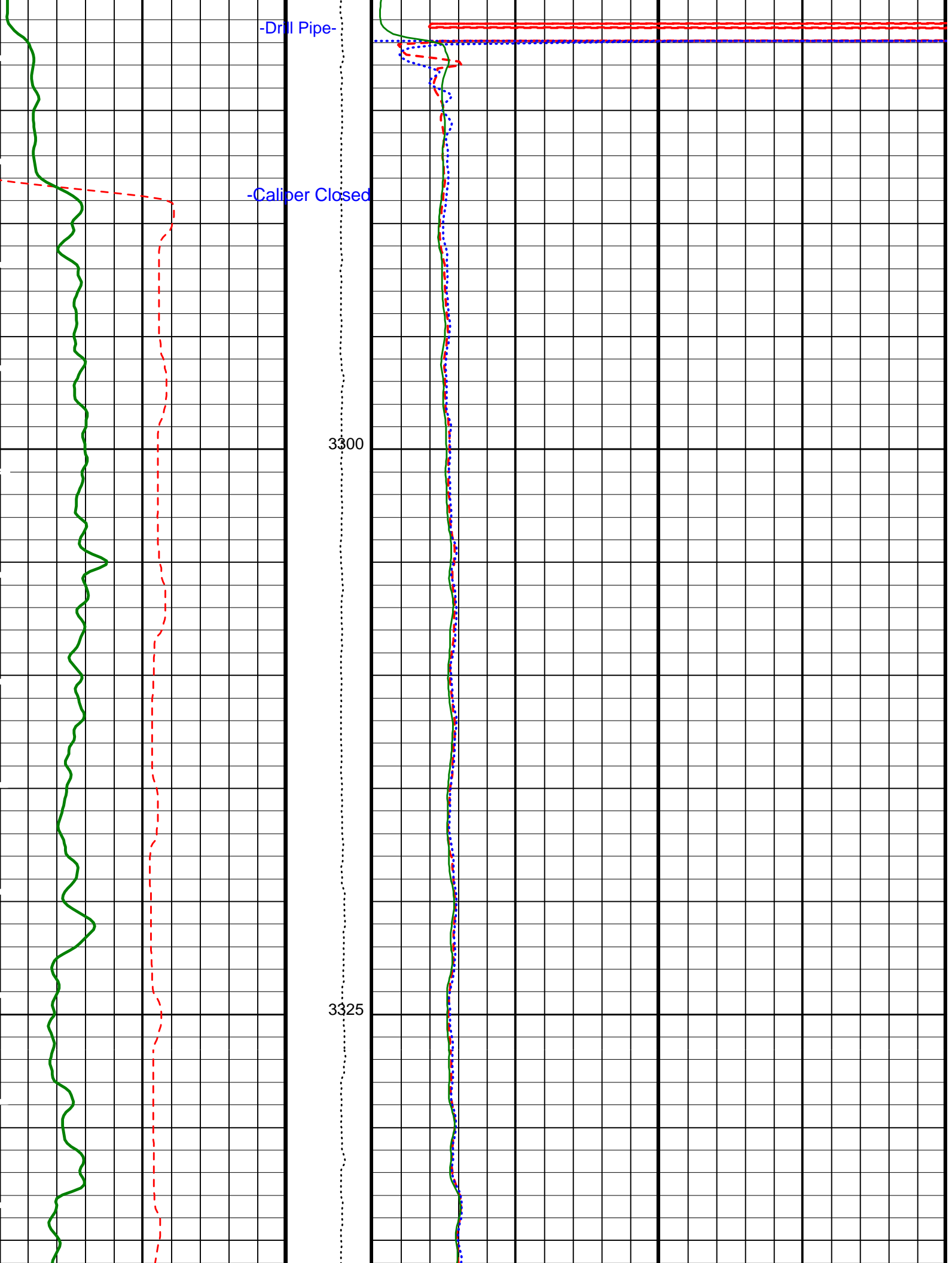

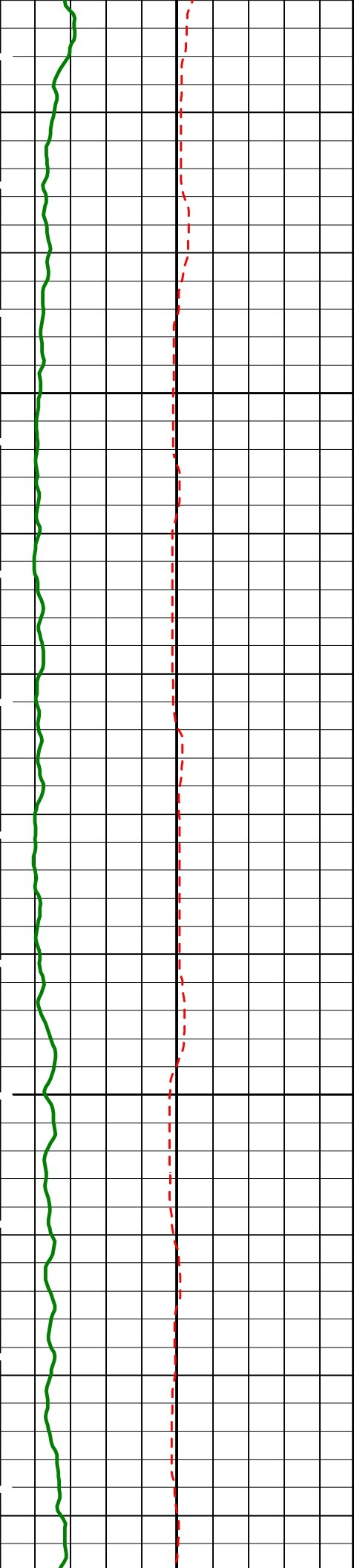

3350

3375

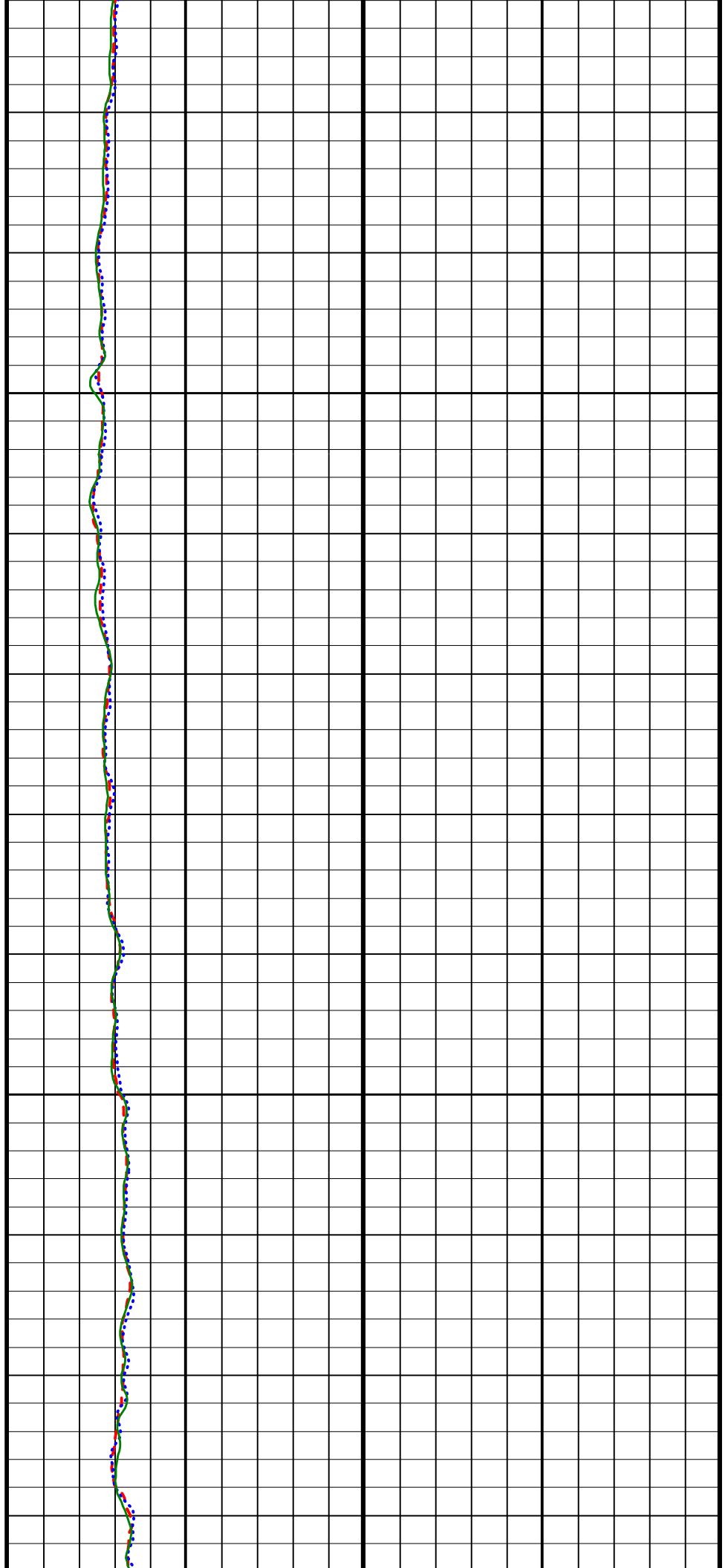



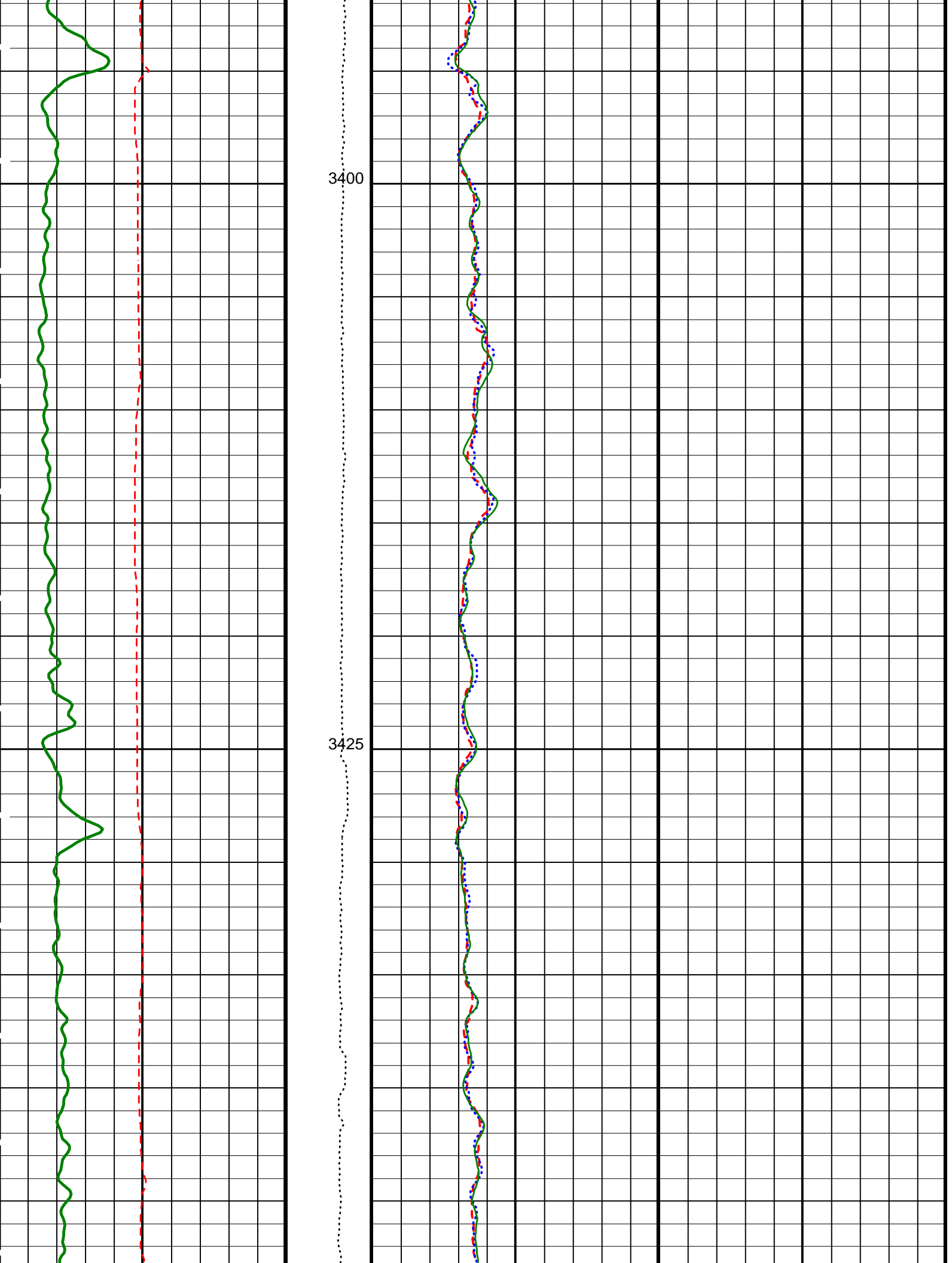

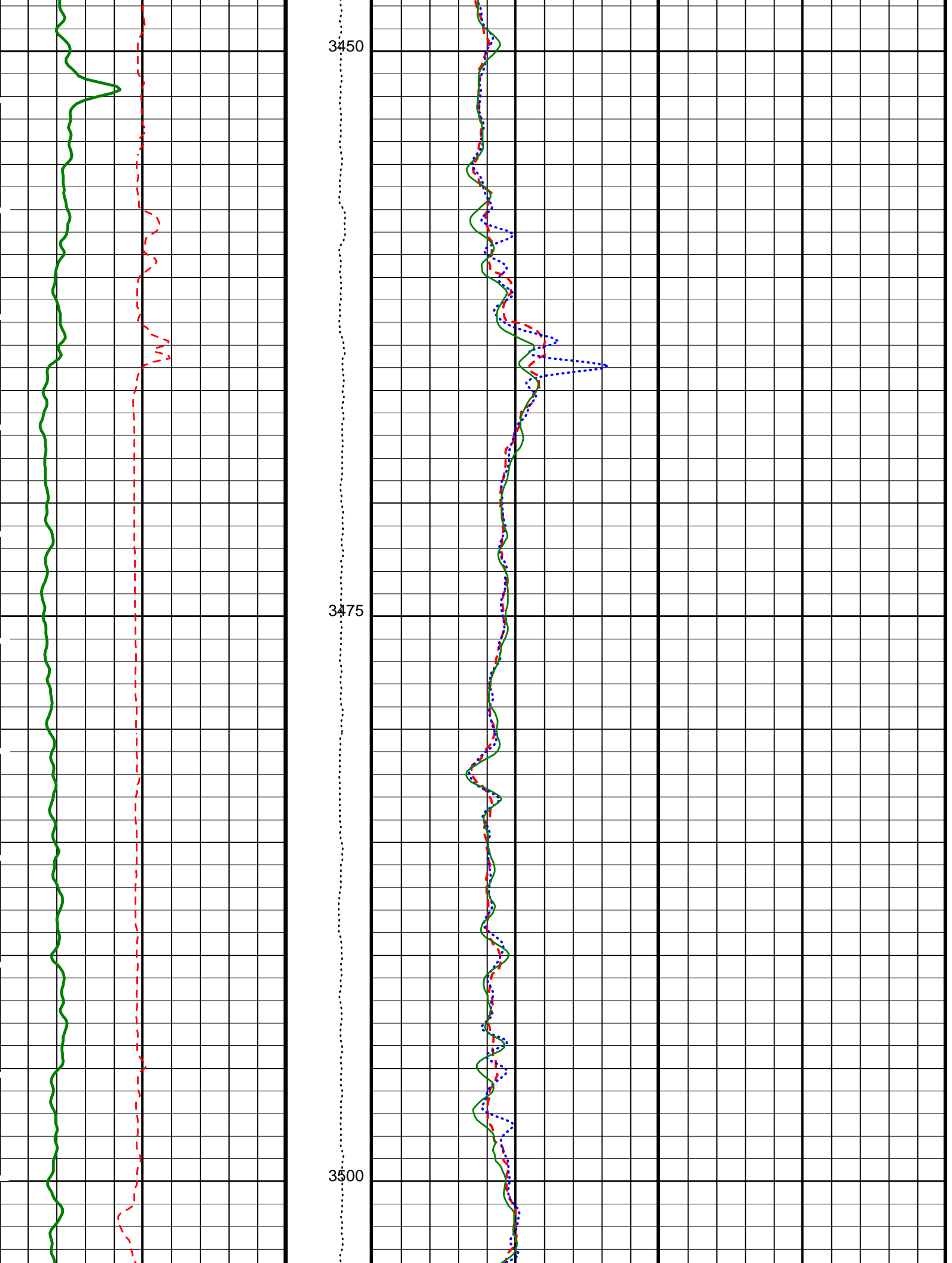

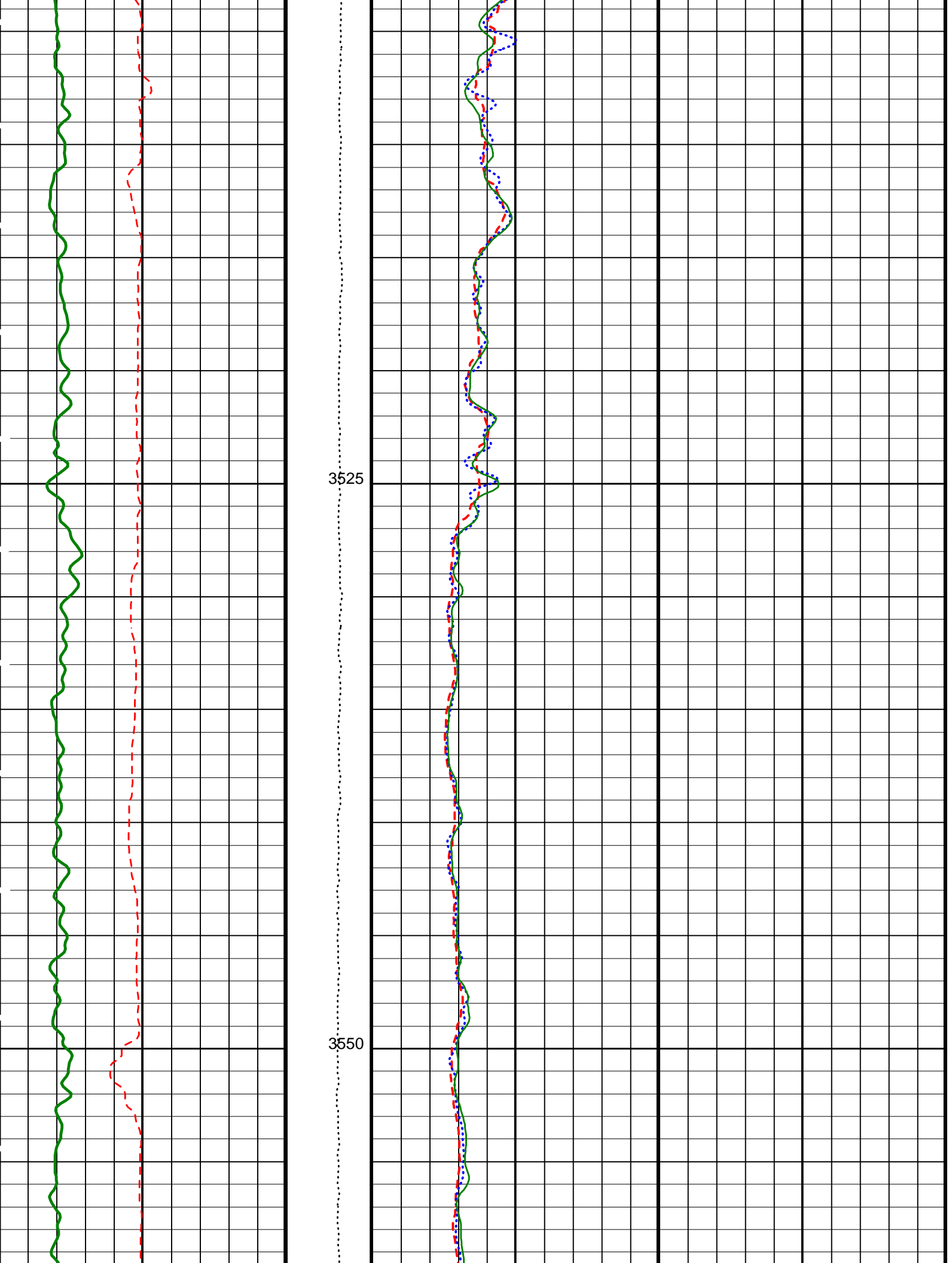

3525

3550

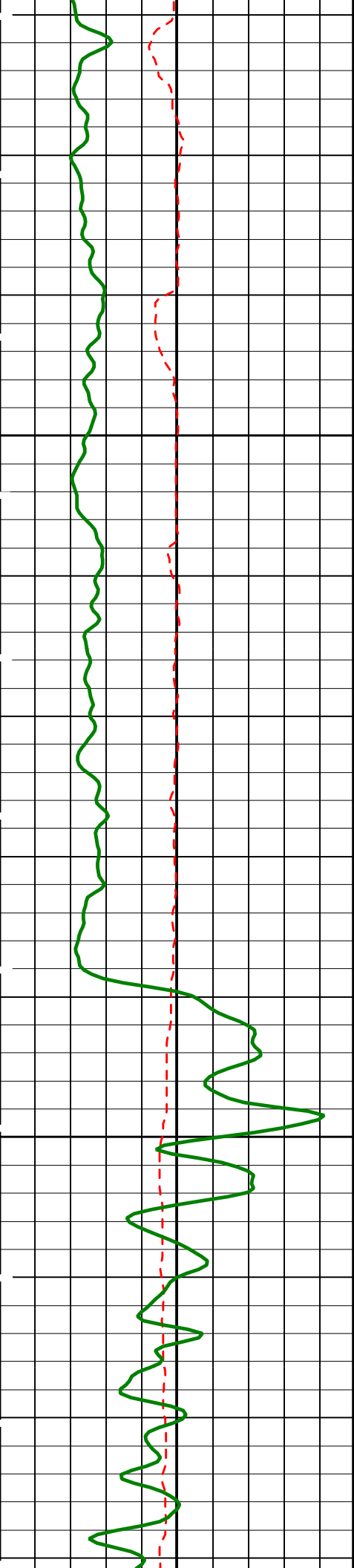

3575

3600

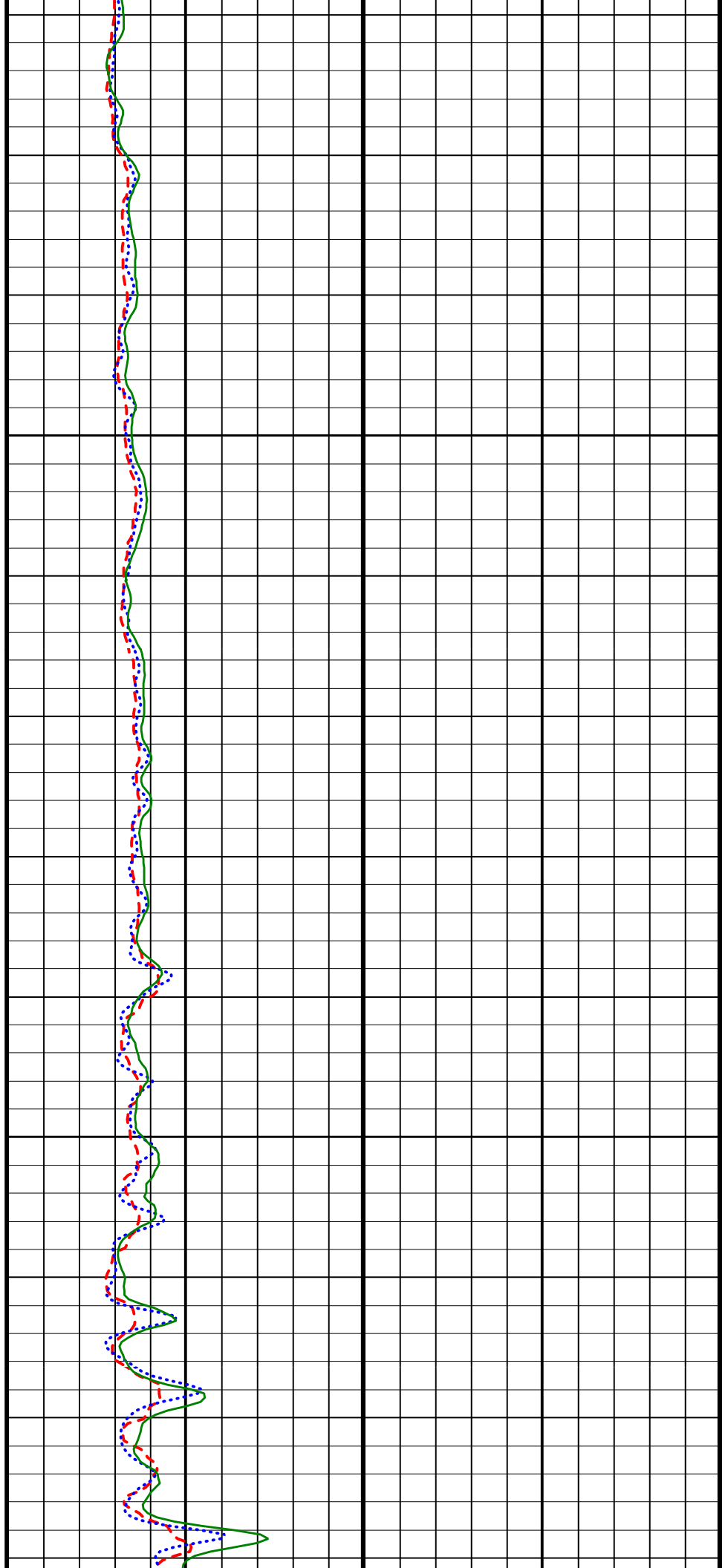

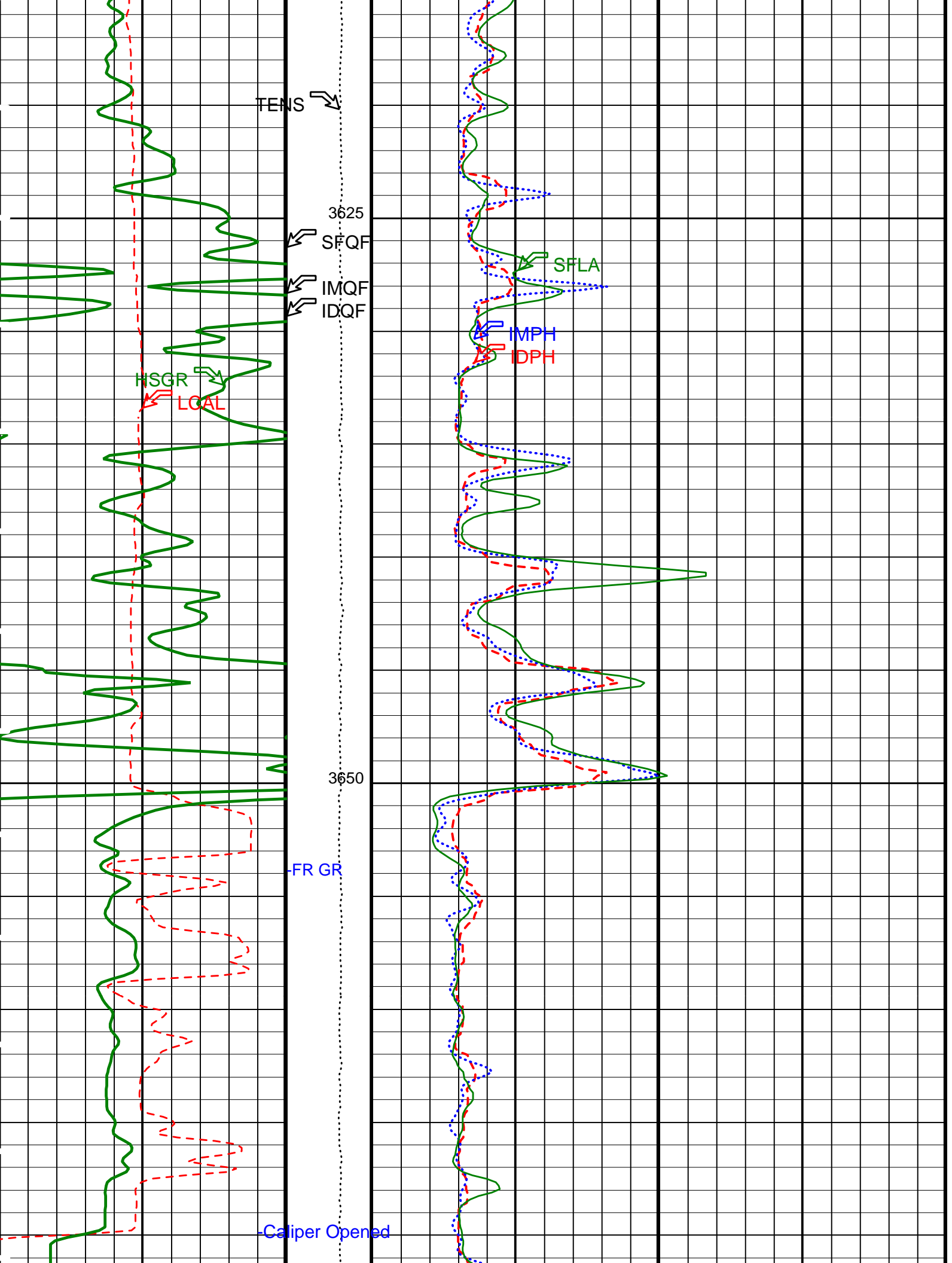

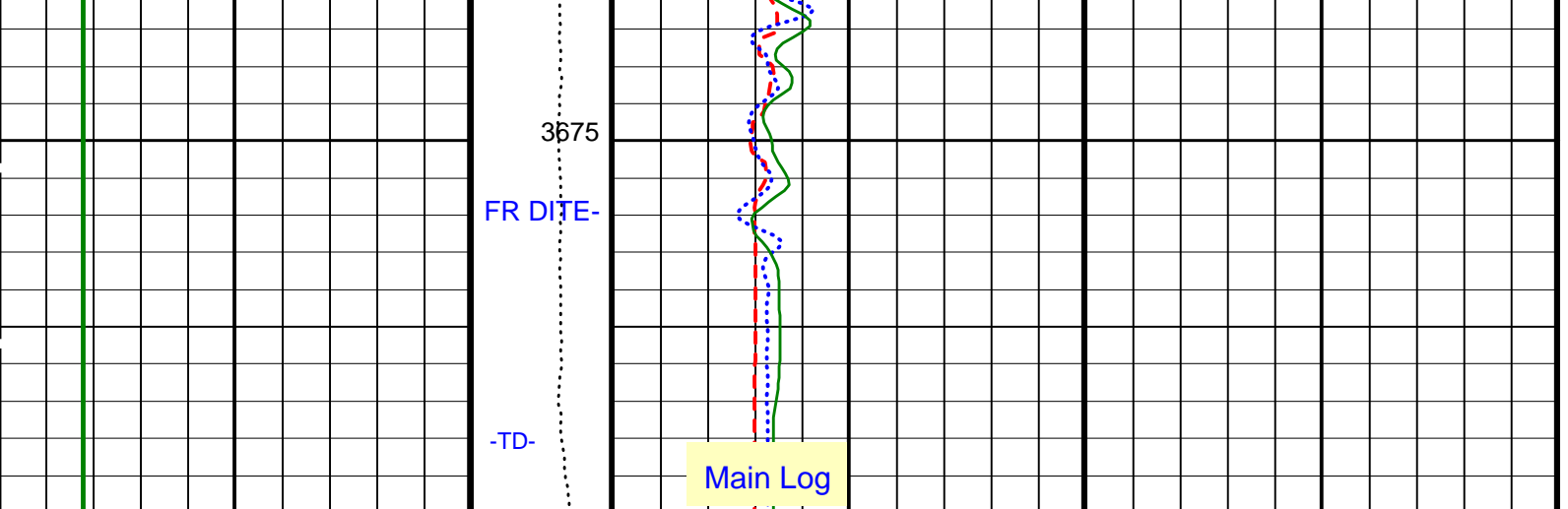

HLDS Caliper (LCAL) (IN)	Tension (TENS) (LBF)	Deep Induction Phasor-processed Resistivity (IDPH) (OHMM)
0 20	10000 0	0 10
HNGS Spectroscopy Gamma Ray (HSGR) (GAPI)	ID_QUAL From IMQF to IDQF	Medium Induction Phasor-processed Resistivity (IMPH) (OHMM)
0 150		0 10
	IM_QUAL From SFQF to IMQF	SFL Averaged (SFLA) (OHMM)
		0 10
	SFL_QUAL From D3T to SFQF	

PIP SUMMARY

Time Mark Every 60 S

Parameters

DLIS Name	Description	Value
DIT-E: Dual Induction - E		
BHS	Borehole Status	OPEN
BHT	Bottom Hole Temperature (used in calculations)	12 DEGC
DGF2	Deep 20 kHz Gain Factor	1.00789
DPH2	Deep 20 kHz Phase Shift	-0.152394 DEG
DRE2	Deep Real 20 kHz Sonde Error Correction	16.357 MM/M
DSR2	Deep Sigma Reference (20 kHz)	1843 MM/M
DXE2	Deep Quad 20 kHz Sonde Error Correction	64.6326 MM/M
GCSE	Generalized Caliper Selection	LCAL
GDEV	Average Angular Deviation of Borehole from Normal	0 DEG
GGRD	Geothermal Gradient	0.018227 DC/M
GTSE	Generalized Temperature Selection	LINEAR_ESTIMATE
IFRS	DIT-E Induction Frequency Selector	20
IPHA	DIT-E Phasor Processing Mode	ALL
IPRO	DIT-E Induction Processing Selector	PHASOR
ITEN	DIT-E Temperature Enable	ENABLE
MGF2	Medium 20 kHz Gain Factor	1.02964
MPH2	Medium 20 kHz Phase Shift	-0.933067 DEG
MRE2	Medium Real 20 kHz Sonde Error Correction	-1.78642 MM/M
MSR2	Medium Sigma Reference (20 kHz)	3250 MM/M
MXE2	Medium Quad 20 kHz Sonde Error Correction	-34.2041 MM/M
SFCR	SFL Channel Ratio	1000
SHT	Surface Hole Temperature	20 DEGC
APS-BA: Accelerator-Porosity Tool		
BHS	Borehole Status	OPEN
BHT	Bottom Hole Temperature (used in calculations)	12 DEGC
GCSE	Generalized Caliper Selection	LCAL
GDEV	Average Angular Deviation of Borehole from Normal	0 DEG
GGRD	Geothermal Gradient	0.018227 DC/M
GTSE	Generalized Temperature Selection	LINEAR_ESTIMATE
SHT	Surface Hole Temperature	20 DEGC

HNGS-BA: Hostile Natural Gamma Ray Sonde

BAR1	HNGS Detector 1 Barite Constant	1	
BAR2	HNGS Detector 2 Barite Constant	1	
BHK	HNGS Borehole Potassium Correction Concentration	0	
BHS	Borehole Status	OPEN	
BHT	Bottom Hole Temperature (used in calculations)	12	DEGC
CSD1	Inner Casing Outer Diameter	0	IN
CSD2	Outer Casing Outer Diameter	0	IN
CSW1	Inner Casing Weight	0	LB/F
CSW2	Outer Casing Weight	0	LB/F
DBCC	HNGS Barite Constant Correction Flag	NONE	
GCSE	Generalized Caliper Selection	LCAL	
GDEV	Average Angular Deviation of Borehole from Normal	0	DEG
GGRD	Geothermal Gradient	0.018227	DC/M
GTSE	Generalized Temperature Selection	LINEAR_ESTIMATE	
H1P	HNGS Detector 1 Allow/Disallow In Processing	ALLOW	
H2P	HNGS Detector 2 Allow/Disallow In Processing	ALLOW	
HABK	HNGS Borehole Potassium Running Average	-0.0398722	
HALF	HNGS Alpha Filter Length	60	IN
HCRB	HNGS Apply Borehole Potassium Correction	NONE	
HMWM	Mud Weighting Material	NATU	
HNPE	HNGS Processing Enable	YES	
S1BI	HNGS Detector 1 Calibration Bismuth Count Rate	-999.25	CPS
S2BI	HNGS Detector 2 Calibration Bismuth Count Rate	-999.25	CPS
SGRC	HNGS Standard Gamma-Ray Correction Flag	YES	
SHT	Surface Hole Temperature	20	DEGC
TPOS	Tool Position	ECCE	
VBA1	HNGS Detector 1 Variable Barite Factor Running Average	0.960314	
VBA2	HNGS Detector 2 Variable Barite Factor Running Average	0.969236	
<b>System and Miscellaneous</b>			
BS	Bit Size	9.875	IN
DFD	Drilling Fluid Density	1.10	G/C3
TD	Total Depth	-50000	M

Format: DITE\_LinPhasor      Vertical Scale: 1:200      Graphics File Created: 31-Jan-2003 07:13

**OP System Version: 10C0-306**  
MCM

DIT-E	10C0-306	DTA-A	10C0-306
HLDS	SPC-2277-NUCL_b	NPLC-B	OP10-KP1
APS-BA	SPC-2277-NUCL_b	HNGS-BA	SPC-2277-NUCL_b
DTC-H	10C0-306		

**Output DLIS Files**

DEFAULT	PI_LDL_APS_NGS_005LUP	FN:6	PRODUCER	31-Jan-2003 07:13
REDUCE	PI_LDL_APS_NGS_005LUP	FN:7	PRODUCER	31-Jan-2003 07:13

**Output DLIS Files**

DEFAULT	PI_LDL_APS_NGS_006LUP	FN:8	PRODUCER	31-Jan-2003 09:09	3685.0 M	3261.4 M
REDUCE	PI_LDL_APS_NGS_006LUP	FN:9	PRODUCER	31-Jan-2003 09:09	3685.0 M	3261.4 M

**OP System Version: 10C0-306**  
MCM

DIT-E	10C0-306	DTA-A	10C0-306
HLDS	SPC-2277-NUCL_b	NPLC-B	OP10-KP1
APS-BA	SPC-2277-NUCL_b	HNGS-BA	SPC-2277-NUCL_b
DTC-H	10C0-306		

**PIP SUMMARY**

Time Mark Every 60 S

SFL\_QUAL  
From D3T  
to SFQF

IM\_QUAL  
From  
SFQF to  
IMQF

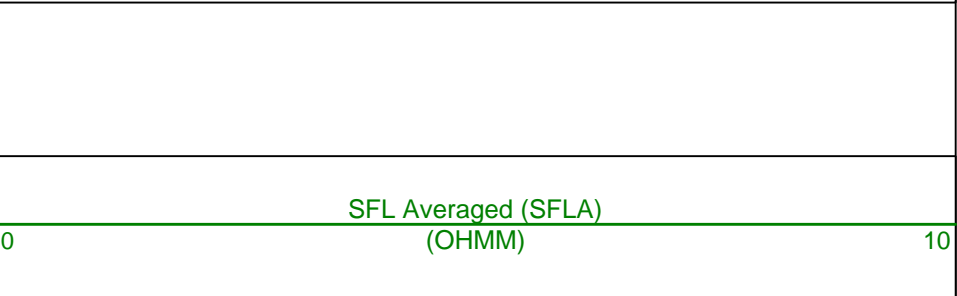

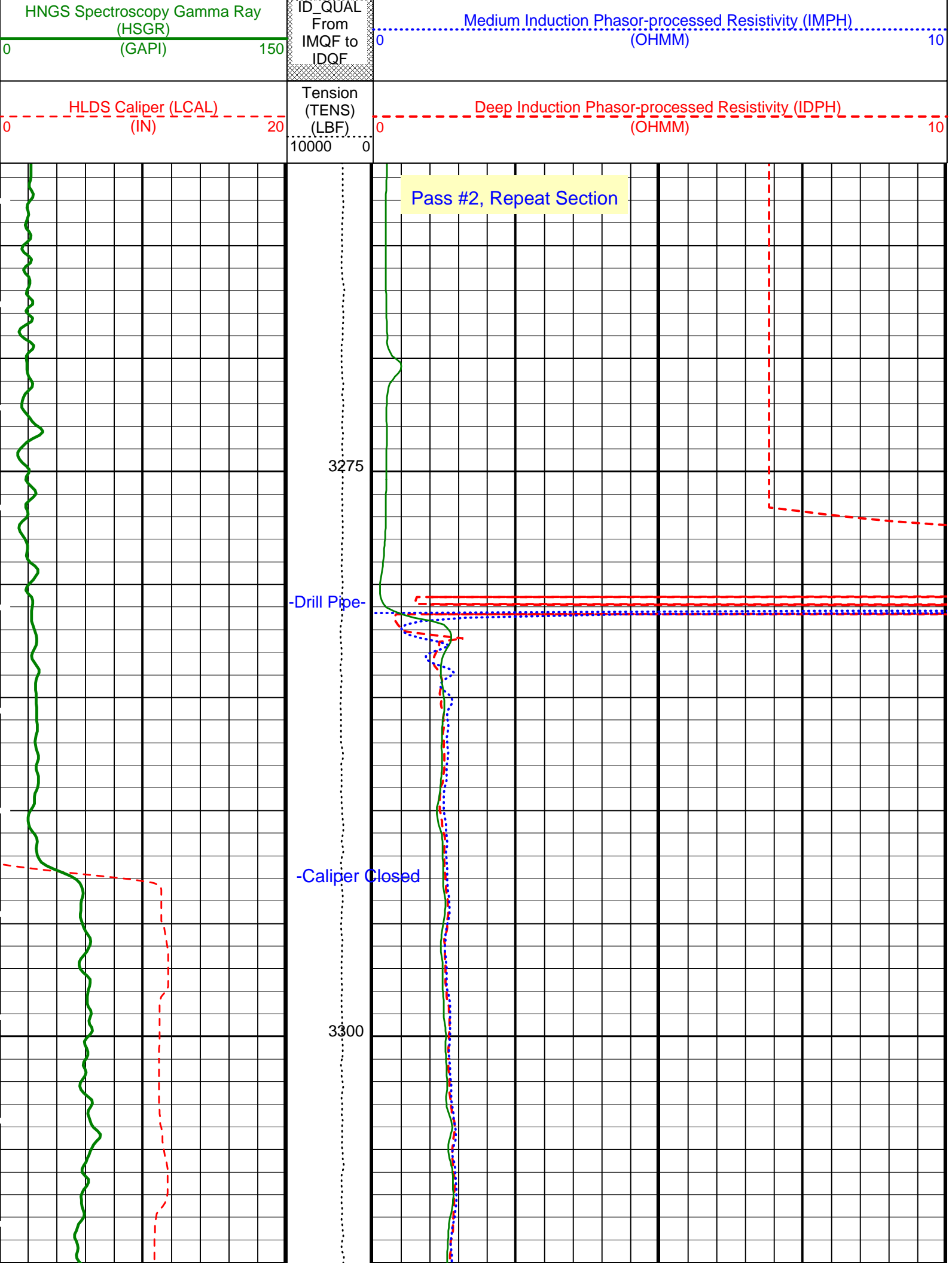



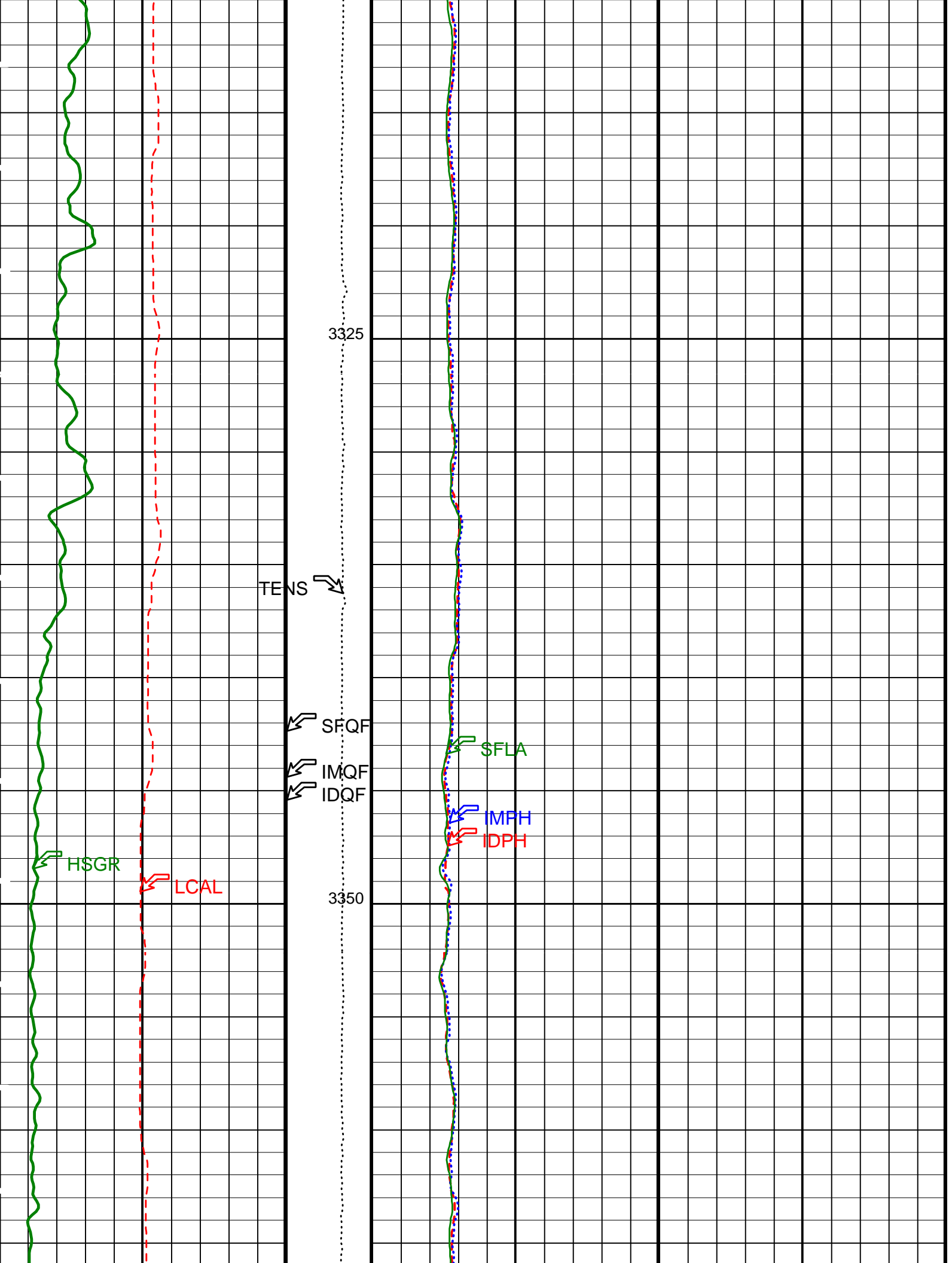

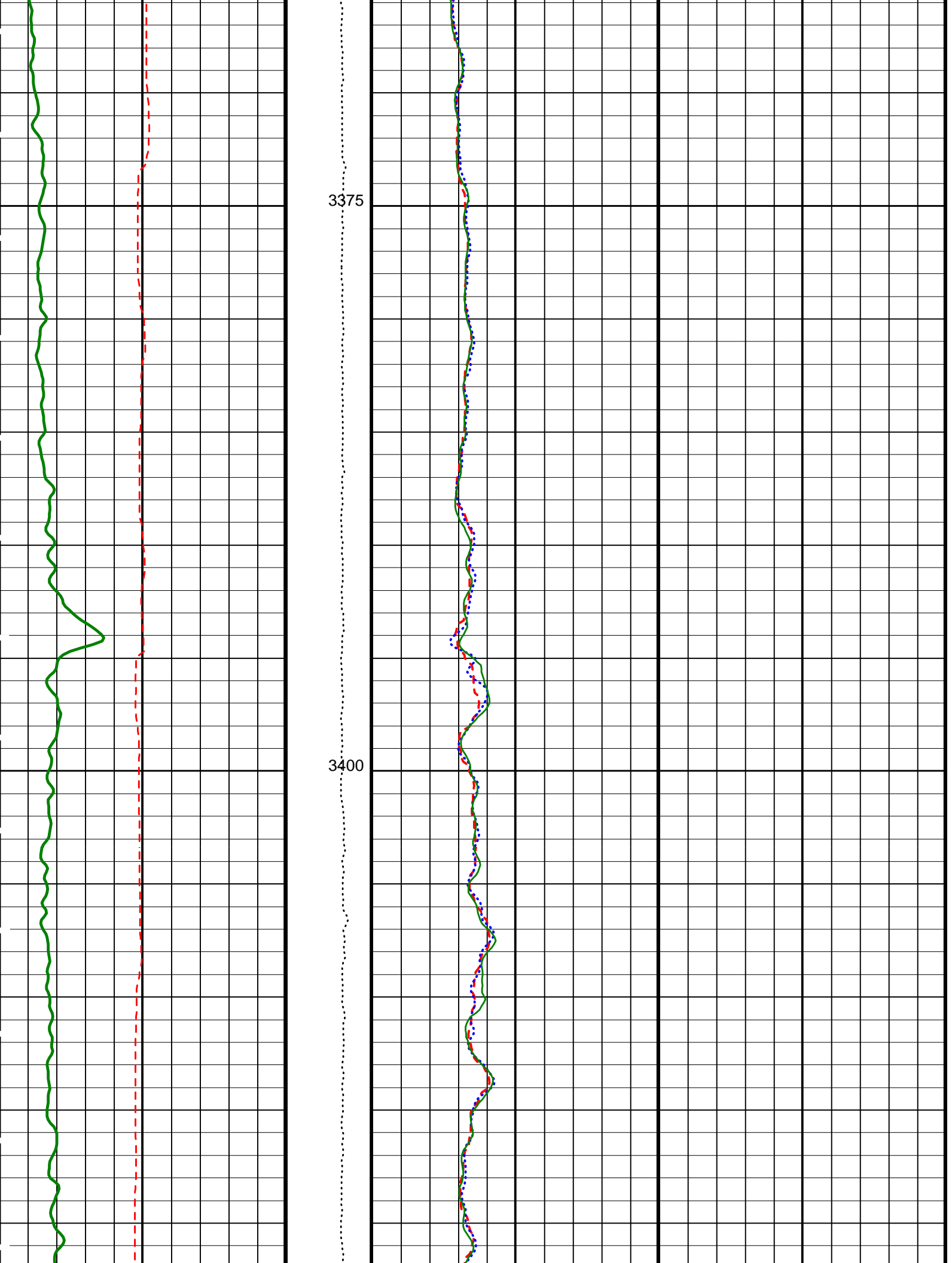

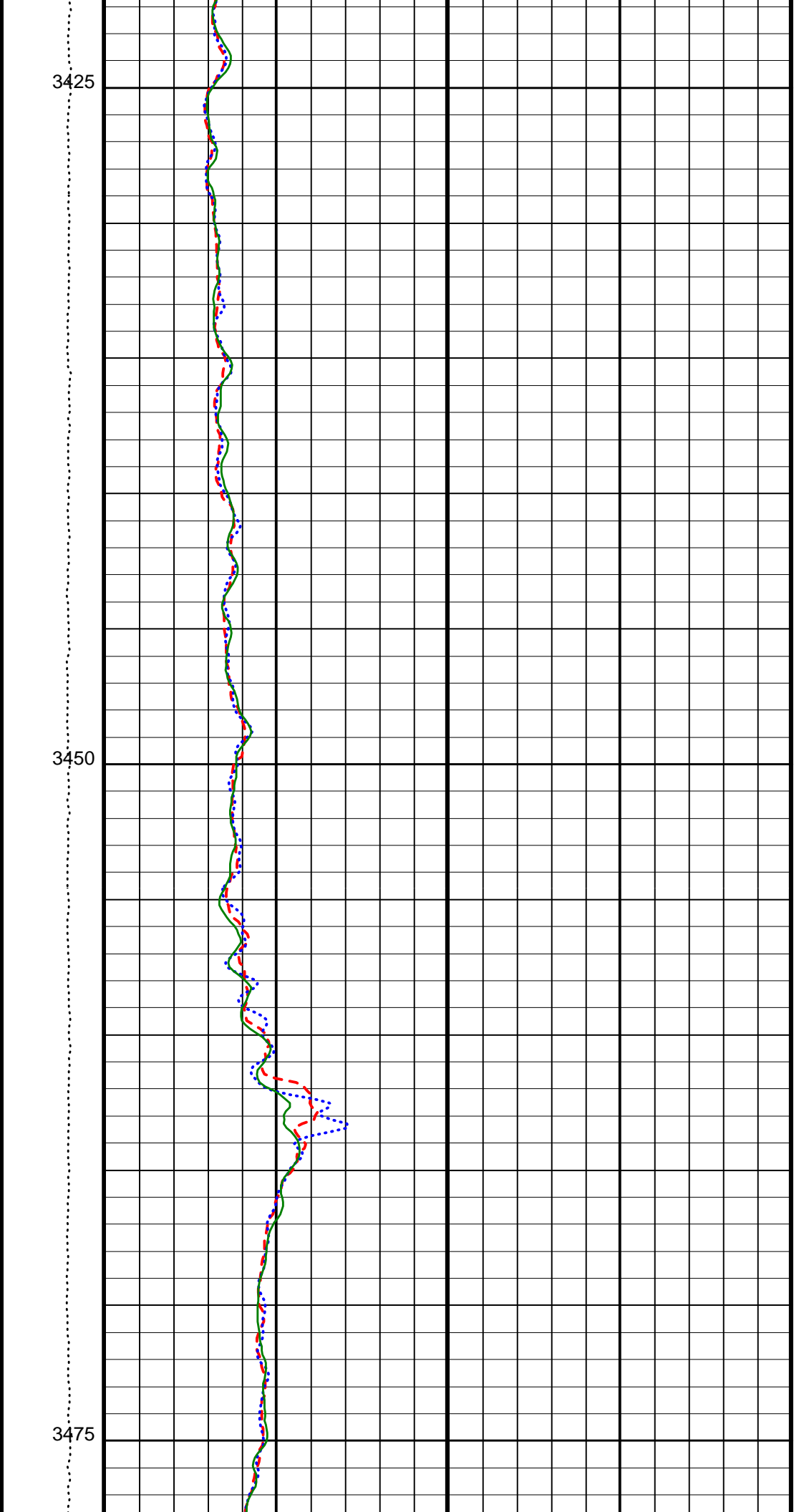
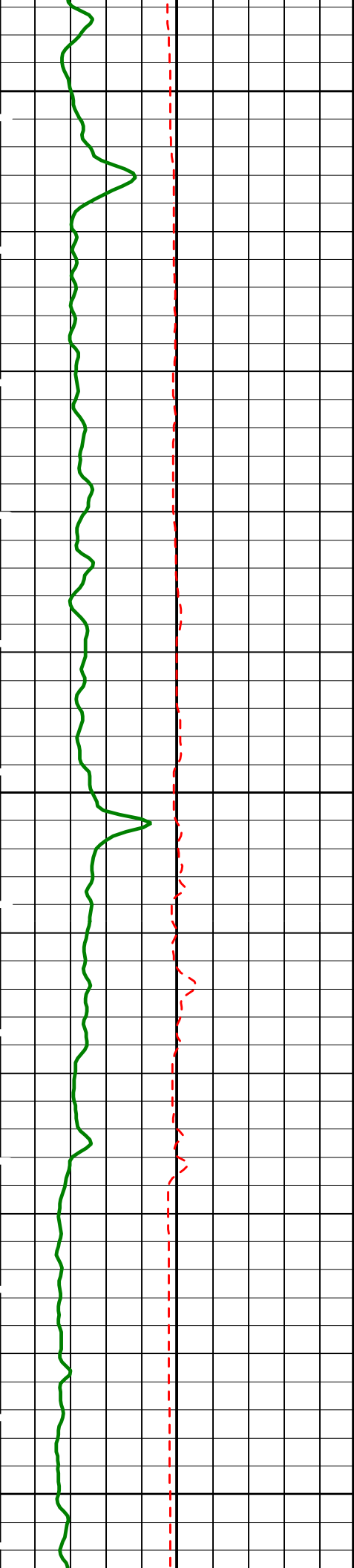

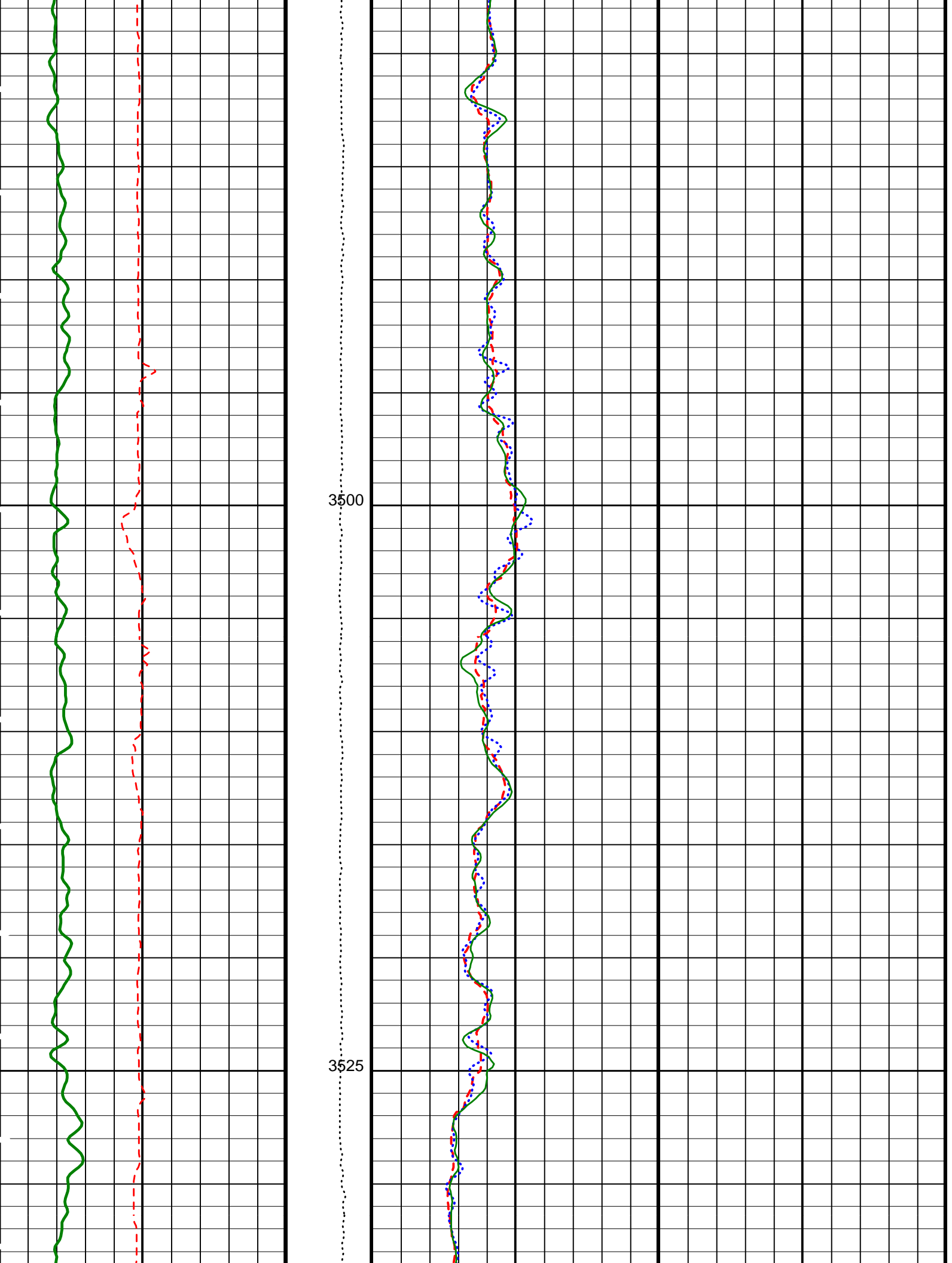

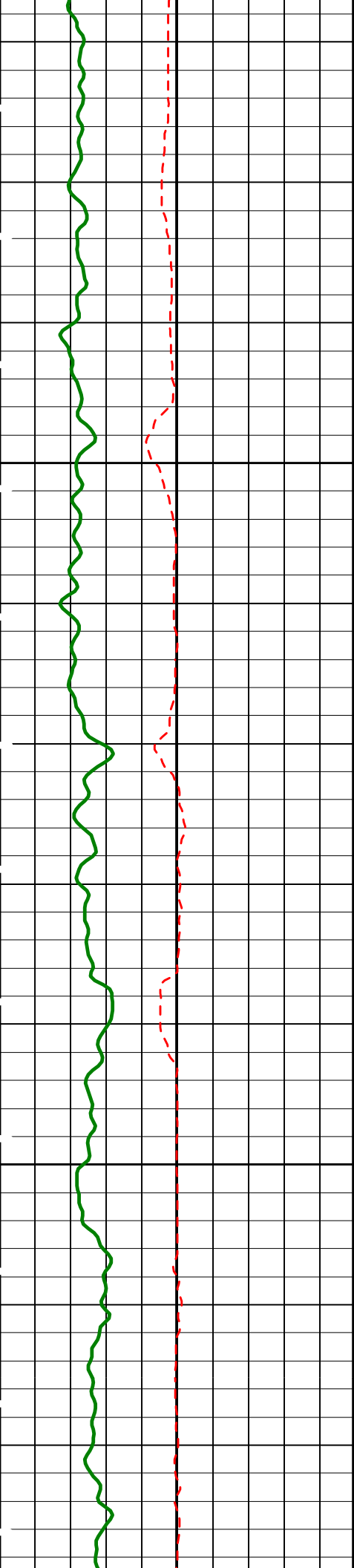

3550

3575

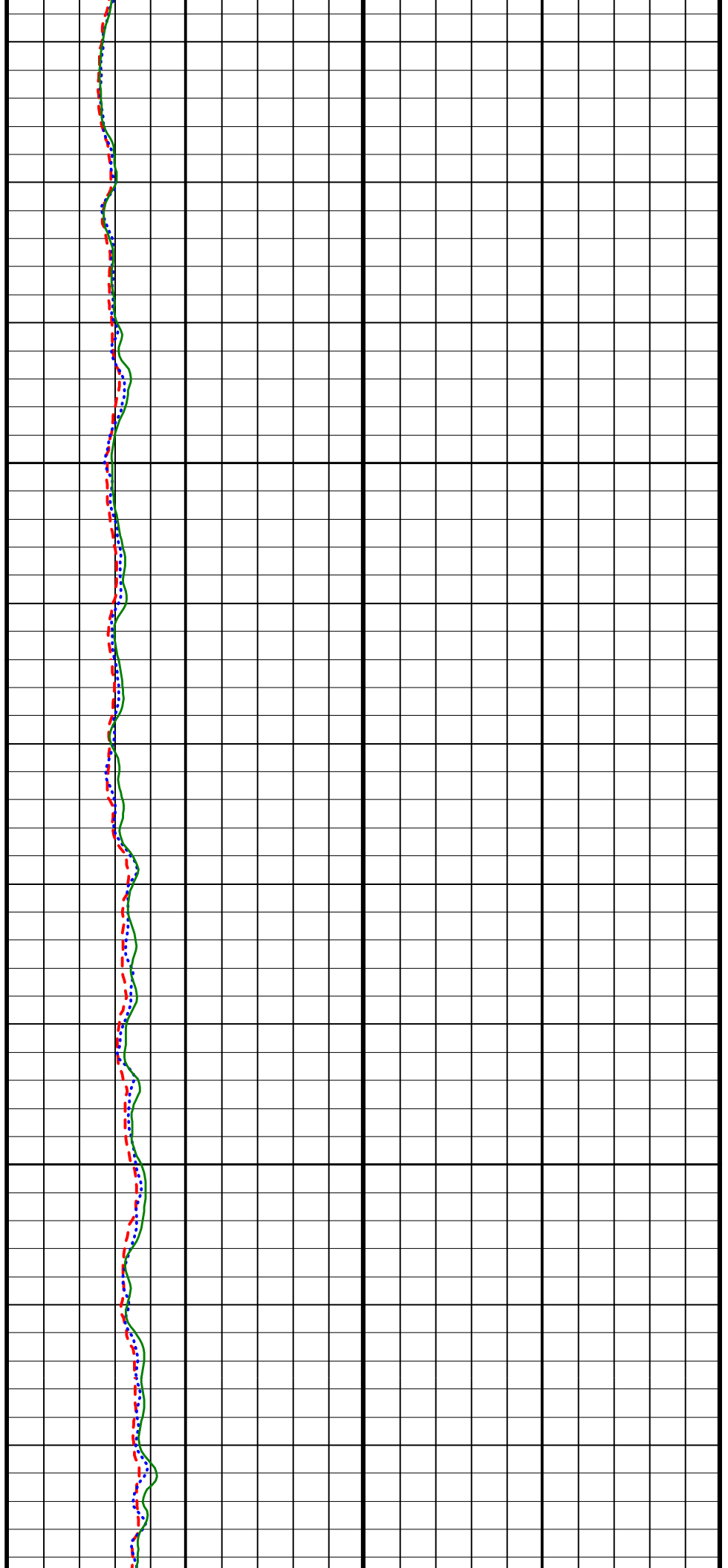

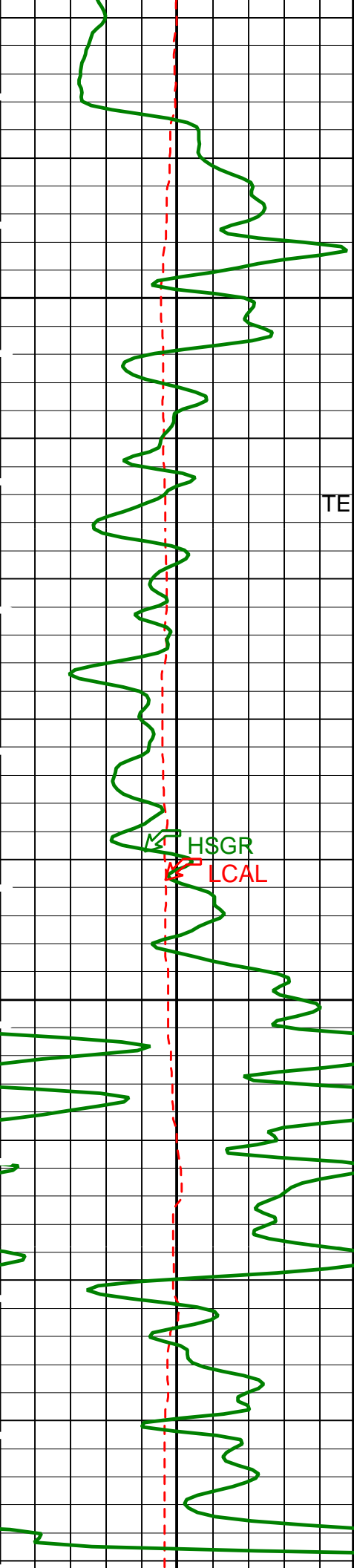

TENS ↘  
↙ SFQF  
↙ IMQF  
↙ IDQF  
↙ HSGR  
↙ LCAL

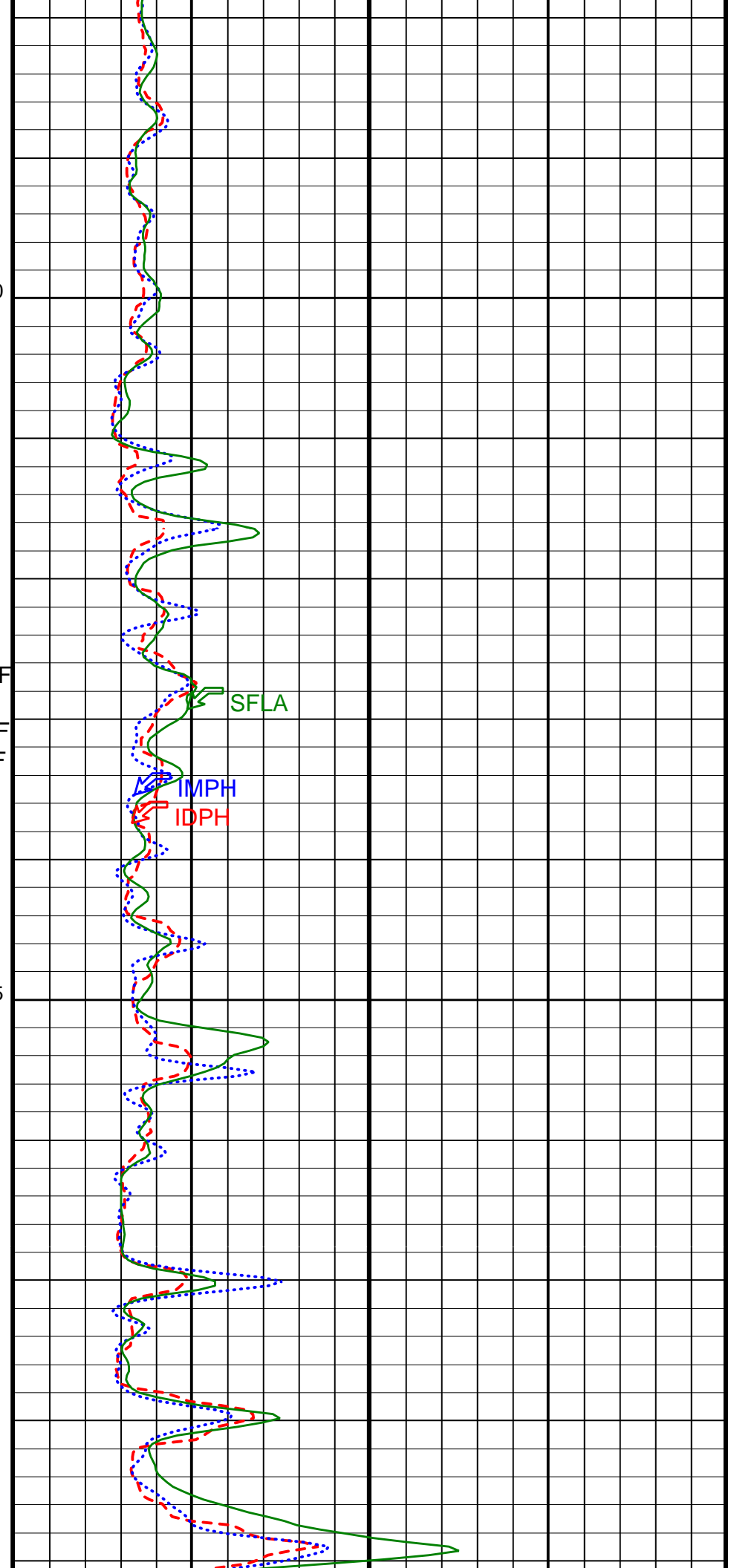

3600

3625

SFLA

IMPH

IDPH

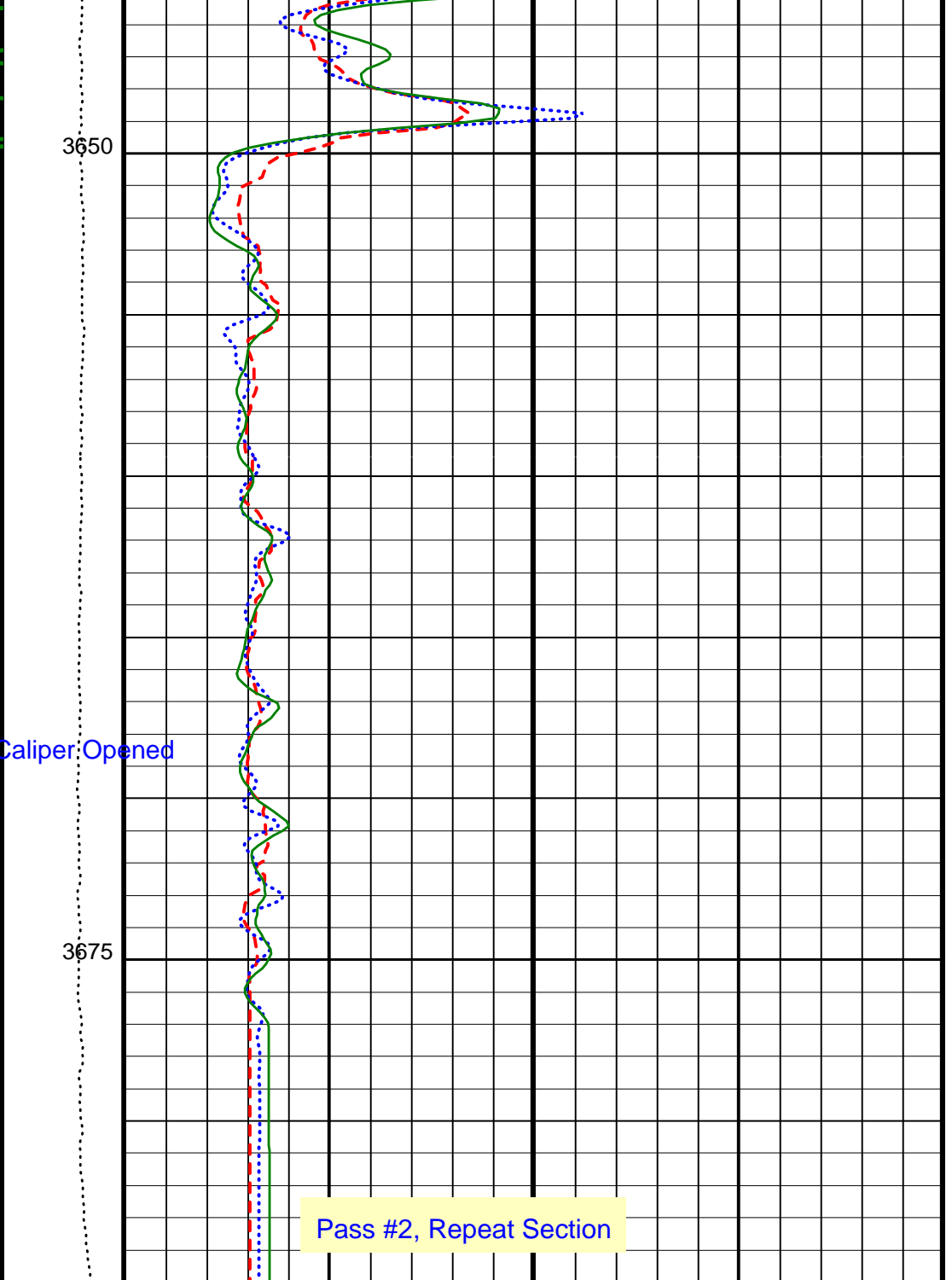
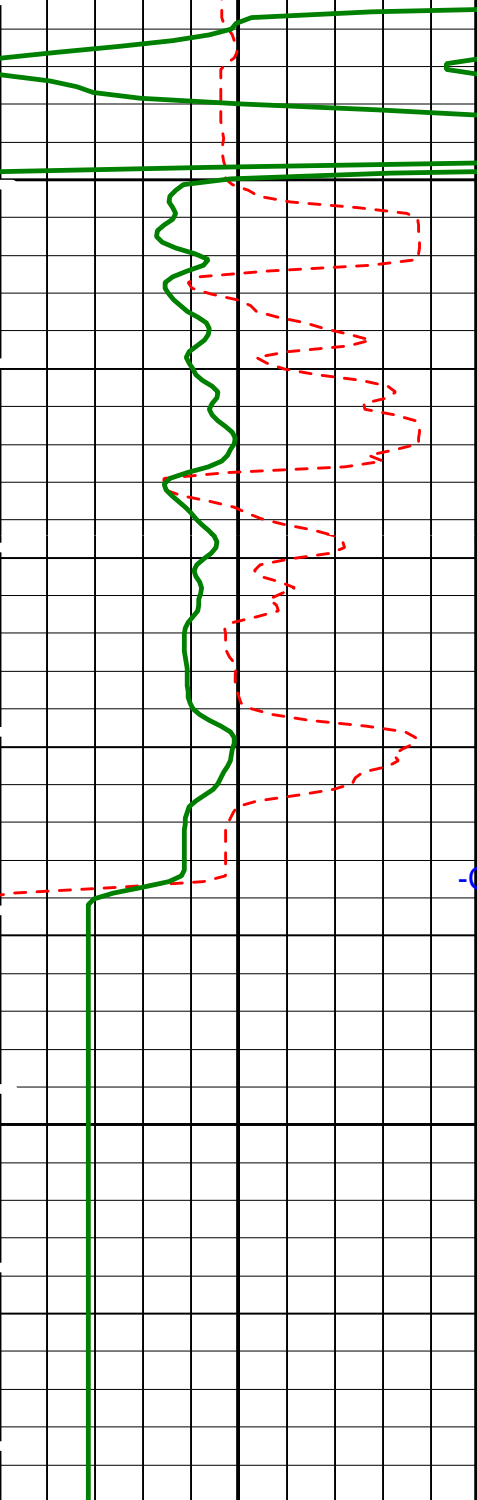

HLDS Caliper (LCAL)  
(IN) 0 20

Tension  
(TENS)  
(LBF) 0 10000

Deep Induction Phasor-processed Resistivity (IDPH)  
(OHMM) 0 10

HNGS Spectroscopy Gamma Ray  
(HSGR)  
(GAPI) 0 150

ID\_QUAL  
From  
IMQF to  
IDQF

Medium Induction Phasor-processed Resistivity (IMPH)  
(OHMM) 0 10

IM\_QUAL  
From  
SFQF to  
IMQF

SFL Averaged (SFLA)  
(OHMM) 0 10

SFL\_QUAL  
From D3T  
to SFQF

## Parameters

DLIS Name	Description	Value	
DIT-E: Dual Induction - E			
BHS	Borehole Status	OPEN	
BHT	Bottom Hole Temperature (used in calculations)	12	DEGC
DGF2	Deep 20 kHz Gain Factor	1.00789	
DPH2	Deep 20 kHz Phase Shift	-0.152394	DEG
DRE2	Deep Real 20 kHz Sonde Error Correction	16.357	MM/M
DSR2	Deep Sigma Reference (20 kHz)	1843	MM/M
DXE2	Deep Quad 20 kHz Sonde Error Correction	64.6326	MM/M
GCSE	Generalized Caliper Selection	LCAL	
GDEV	Average Angular Deviation of Borehole from Normal	0	DEG
GGRD	Geothermal Gradient	0.018227	DC/M
GTSE	Generalized Temperature Selection	LINEAR_ESTIMATE	
IFRS	DIT-E Induction Frequency Selector	20	
IPHA	DIT-E Phasor Processing Mode	ALL	
IPRO	DIT-E Induction Processing Selector	PHASOR	
ITEN	DIT-E Temperature Enable	ENABLE	
MGF2	Medium 20 kHz Gain Factor	1.02964	
MPH2	Medium 20 kHz Phase Shift	-0.933067	DEG
MRE2	Medium Real 20 kHz Sonde Error Correction	-1.78642	MM/M
MSR2	Medium Sigma Reference (20 kHz)	3250	MM/M
MXE2	Medium Quad 20 kHz Sonde Error Correction	-34.2041	MM/M
SFCR	SFL Channel Ratio	1000	
SHT	Surface Hole Temperature	20	DEGC
APS-BA: Accelerator-Porosity Tool			
BHS	Borehole Status	OPEN	
BHT	Bottom Hole Temperature (used in calculations)	12	DEGC
GCSE	Generalized Caliper Selection	LCAL	
GDEV	Average Angular Deviation of Borehole from Normal	0	DEG
GGRD	Geothermal Gradient	0.018227	DC/M
GTSE	Generalized Temperature Selection	LINEAR_ESTIMATE	
SHT	Surface Hole Temperature	20	DEGC
HNGS-BA: Hostile Natural Gamma Ray Sonde			
BAR1	HNGS Detector 1 Barite Constant	1	
BAR2	HNGS Detector 2 Barite Constant	1	
BHK	HNGS Borehole Potassium Correction Concentration	0	
BHS	Borehole Status	OPEN	
BHT	Bottom Hole Temperature (used in calculations)	12	DEGC
CSD1	Inner Casing Outer Diameter	0	IN
CSD2	Outer Casing Outer Diameter	0	IN
CSW1	Inner Casing Weight	0	LB/F
CSW2	Outer Casing Weight	0	LB/F
DBCC	HNGS Barite Constant Correction Flag	NONE	
GCSE	Generalized Caliper Selection	LCAL	
GDEV	Average Angular Deviation of Borehole from Normal	0	DEG
GGRD	Geothermal Gradient	0.018227	DC/M
GTSE	Generalized Temperature Selection	LINEAR_ESTIMATE	
H1P	HNGS Detector 1 Allow/Disallow In Processing	ALLOW	
H2P	HNGS Detector 2 Allow/Disallow In Processing	ALLOW	
HABK	HNGS Borehole Potassium Running Average	-0.0152604	
HALF	HNGS Alpha Filter Length	60	IN
HCRB	HNGS Apply Borehole Potassium Correction	NONE	
HMWM	Mud Weighting Material	NATU	
HNPE	HNGS Processing Enable	YES	
S1BI	HNGS Detector 1 Calibration Bismuth Count Rate	-999.25	CPS
S2BI	HNGS Detector 2 Calibration Bismuth Count Rate	-999.25	CPS
SGRC	HNGS Standard Gamma-Ray Correction Flag	YES	
SHT	Surface Hole Temperature	20	DEGC
TPOS	Tool Position	ECCE	
VBA1	HNGS Detector 1 Variable Barite Factor Running Average	0.972818	
VBA2	HNGS Detector 2 Variable Barite Factor Running Average	0.982813	
System and Miscellaneous			
BS	Bit Size	9.875	IN
DFD	Drilling Fluid Density	1.10	G/C3
TD	Total Depth	-50000	M

Format: DITE\_LinPhasor Vertical Scale: 1:200

Graphics File Created: 31-Jan-2003 09:09

OP System Version: 10C0-306  
MCM

DIT-E	10C0-306	DTA-A	10C0-306
HLDS	SPC-2277-NUCL_b	NPLC-B	OP10-KP1
APS-BA	SPC-2277-NUCL_b	HNGS-BA	SPC-2277-NUCL_b
DTC-H	10C0-306		



# Output DLIS Files

DEFAULT	PI_LDL_APS_NGS_006LUP	FN:8	PRODUCER	31-Jan-2003 09:09
REDUCE	PI_LDL_APS_NGS_006LUP	FN:9	PRODUCER	31-Jan-2003 09:09

## Calibration and Check Summary

Measurement	Nominal	Master	Before	After	Change	Limit	Units
<b>Hostile Litho-Density Sonde Wellsite Calibration - Background Measurement</b>							
Master: 13-Dec-2002 14:00 Before: 15-Jan-2003 11:10 After: 31-Jan-2003 17:05							
SS Cs Resolution Bkg	9.000	8.065	8.135	8.015	-0.1196	1.800	%
LS Cs Resolution Bkg	9.000	8.249	8.108	8.087	-0.02139	1.800	%
LSW1 Background	100.0	86.88	86.46	87.40	0.9397	0.03000	CPS
LSW2 Background	100.0	82.90	80.84	82.04	1.202	0.03000	CPS
LSW3 Background	200.0	182.1	179.4	182.1	2.733	0.03000	CPS
LSW4 Background	250.0	221.9	216.6	221.3	4.695	0.03000	CPS
LSW5 Background	600.0	510.1	505.1	504.3	-0.8560	0.03000	CPS
SSW1 Background	100.0	96.14	98.01	97.37	-0.6340	0.03000	CPS
SSW2 Background	200.0	176.7	177.3	174.6	-2.675	0.03000	CPS
SSW3 Background	500.0	478.2	477.6	476.6	-0.9975	0.03000	CPS
SSW4 Background	270.0	244.1	244.0	243.2	-0.8002	0.03000	CPS
SSW5 Background	200.0	177.5	175.7	176.8	1.146	0.03000	CPS
<b>Hostile Litho-Density Sonde Wellsite Calibration - Aluminum Measurement</b>							
Master: 13-Dec-2002 15:15							
LSW1 Aluminum	600.0	580.8	N/A	N/A	N/A	N/A	CPS
LSW2 Aluminum	900.0	822.1	N/A	N/A	N/A	N/A	CPS
LSW3 Aluminum	1100	985.4	N/A	N/A	N/A	N/A	CPS
LSW4 Aluminum	580.0	489.2	N/A	N/A	N/A	N/A	CPS
LSW5 Aluminum	570.0	453.3	N/A	N/A	N/A	N/A	CPS
SSW1 Aluminum	2800	2597	N/A	N/A	N/A	N/A	CPS
SSW2 Aluminum	8000	7087	N/A	N/A	N/A	N/A	CPS
SSW3 Aluminum	11600	9849	N/A	N/A	N/A	N/A	CPS
SSW4 Aluminum	5000	4127	N/A	N/A	N/A	N/A	CPS
SSW5 Aluminum	660.0	537.2	N/A	N/A	N/A	N/A	CPS
<b>Hostile Litho-Density Sonde Wellsite Calibration - Lithology Measurement</b>							
Master: 13-Dec-2002 15:11							
LSW1 Iron	400.0	401.7	N/A	N/A	N/A	N/A	CPS
LSW2 Iron	730.0	683.6	N/A	N/A	N/A	N/A	CPS
LSW3 Iron	1000	900.2	N/A	N/A	N/A	N/A	CPS
LSW4 Iron	520.0	465.6	N/A	N/A	N/A	N/A	CPS
LSW5 Iron	470.0	434.8	N/A	N/A	N/A	N/A	CPS
SSW1 Iron	2100	1961	N/A	N/A	N/A	N/A	CPS
SSW2 Iron	6800	6103	N/A	N/A	N/A	N/A	CPS
SSW3 Iron	10800	9305	N/A	N/A	N/A	N/A	CPS
SSW4 Iron	4600	3921	N/A	N/A	N/A	N/A	CPS
SSW5 Iron	580.0	502.8	N/A	N/A	N/A	N/A	CPS
<b>Hostile Litho-Density Sonde Wellsite Calibration - Caliper Calibration</b>							
Before: 15-Jan-2003 11:25							
HLDS Caliper Small Ring	15.00	N/A	18.20	N/A	N/A	N/A	IN
HLDS Caliper Large Ring	17.50	N/A	20.31	N/A	N/A	N/A	IN
<b>Accelerator-Porosity Tool Wellsite Calibration - Detector Background</b>							
Master: 28-Nov-2002 19:52 Before: 31-Jan-2003 6:16 After: 31-Jan-2003 15:40							
Near Det Bkg Cntrate	30.00	32.65	33.77	32.72	-1.051	N/A	CPS
Far Det Bkg Cntrate	30.00	31.56	32.99	33.29	0.3005	N/A	CPS
Array-1 Det Bkg Cntrate	30.00	29.11	28.51	29.23	0.7173	N/A	CPS
Array-2 Det Bkg Cntrate	30.00	29.96	30.18	30.78	0.6006	N/A	CPS
Array Therm Det Bkg Cntrate	30.00	32.97	31.86	32.46	0.5983	N/A	CPS
<b>Accelerator-Porosity Tool Wellsite Calibration - Calibration Ratios</b>							
Master: 28-Nov-2002 19:53							
Near/Far Calibration Ratio	0.9250	0.8869	N/A	N/A	N/A	N/A	N/A
Near/Array Calibration Ratio	1.030	1.051	N/A	N/A	N/A	N/A	N/A
Near/Array Cal Ratio Up/Down	1.000	1.002	N/A	N/A	N/A	N/A	N/A
<b>Accelerator-Porosity Tool Wellsite Calibration - Tank Check</b>							
Master: 28-Nov-2002 19:54							
Array-1 Standoff Porosity	11.75	11.90	N/A	N/A	N/A	N/A	PU
Array-2 Standoff Porosity	11.75	11.44	N/A	N/A	N/A	N/A	PU
Average Slowing Down Time	6.000	5.850	N/A	N/A	N/A	N/A	US
Array-1 SDT Ratio Up/Down	1.000	0.9966	N/A	N/A	N/A	N/A	N/A
Array-2 SDT Ratio Up/Down	1.000	0.9889	N/A	N/A	N/A	N/A	N/A

Array 2 CD1 Ratio Up/Down	1.000	0.9885	N/A	N/A	N/A	N/A	CU
Sigma Formation	27.50	27.81	N/A	N/A	N/A	N/A	
Hostile Natural Gamma Ray Sonde Wellsite Calibration - Detector 1 Check							
Master: 15-Jan-2003 16:08 Before: 15-Jan-2003 16:17 After: 31-Jan-2003 17:06							
Na 511 Peak Loc	40.00	40.59	40.72	40.59	-0.1351	1.000	
Na 511 Peak Res	15.50	17.05	17.42	16.56	-0.8642	2.000	%
High Voltage	1150	1212	1212	1214	1.855	30.00	V
Na 1785 Peak Loc	142.6	145.6	145.3	145.7	0.3604	7.000	
Na 1785 Peak Res	8.500	9.037	9.666	8.507	-1.159	2.000	%
Temperature	15.50	32.69	32.84	29.39	-3.458	N/A	DEGC
Na Count Rate	45.00	44.80	43.98	42.72	-1.260	8.000	CPS

Hostile Natural Gamma Ray Sonde Wellsite Calibration - Detector 2 Check							
Master: 15-Jan-2003 16:08 Before: 15-Jan-2003 16:17 After: 31-Jan-2003 17:06							
Na 511 Peak Loc	40.00	40.55	40.57	40.60	0.02974	1.000	
Na 511 Peak Res	15.50	16.60	16.91	16.65	-0.2540	2.000	%
High Voltage	1150	1239	1239	1242	2.482	30.00	V
Na 1785 Peak Loc	142.6	144.7	144.4	144.6	0.2119	7.000	
Na 1785 Peak Res	8.500	9.925	9.708	9.652	-0.05593	2.000	%
Temperature	15.50	32.80	32.89	29.19	-3.703	N/A	DEGC
Na Count Rate	45.00	44.45	43.98	42.38	-1.601	8.000	CPS

Hostile Natural Gamma Ray Sonde Wellsite Calibration - Ratio Of Detector 1 To Detector 2							
Master: 15-Jan-2003 16:08 Before: 15-Jan-2003 16:17 After: 31-Jan-2003 17:06							
Coincidence Count Rate Ratio	1.000	1.008	1.0000	1.006	0.006140	0.05000	

Hostile Natural Gamma Ray Sonde Master Calibration - Detector 1 Calibration							
Master: 15-Jan-2003 16:01							
Na 511 Peak Set Point	40.00	41.00	--	--	--	--	
Th Peak Loc	209.6	209.3	--	--	--	--	
Th Peak Res	7.000	8.207	--	--	--	--	%
Background Count Rate	142.5	23.15	--	--	--	--	CPS
Gain Ratio	1.000	0.9810	--	--	--	--	

Hostile Natural Gamma Ray Sonde Master Calibration - Detector 2 Calibration							
Master: 15-Jan-2003 16:01							
Na 511 Peak Set Point	40.00	41.00	--	--	--	--	
Th Peak Loc	209.6	209.3	--	--	--	--	
Th Peak Res	7.000	7.848	--	--	--	--	%
Background Count Rate	142.5	21.80	--	--	--	--	CPS
Gain Ratio	1.000	0.9821	--	--	--	--	

Accelerator-Porosity Tool - Detector Plateau Settings :

Near Detector Plateau Setting	1728 V
Far Detector Plateau Setting	2073 V
Array Detector Plateau Setting	1958 V

Dual Induction - E / Equipment Identification		
Primary Equipment:		
Dual Induction Sonde	DIS - HB	442
Dual Induction Cartridge	DIC - EB	438
Auxiliary Equipment:		
Mass Isolated Housing	MIH - ZA	417

Dual Induction - E Wellsite Calibration											
Induction Electronics (10 kHz)											
Phase	ID Elect Real Offset 10 kHz	MM/M	Value	Phase	ID Elect Real Gain 10 kHz	Value	Phase	ID Elect Phase 10 kHz DEG	Value		
Before			37.75	Before		0.9757	Before		EXCEEDS LIMIT 10.92		
	-300.0 (Minimum)	0 (Nominal)	300.0 (Maximum)		0.8500 (Minimum)	1.000 (Nominal)	1.200 (Maximum)		-10.00 (Minimum)	0 (Nominal)	10.00 (Maximum)
Phase	ID Elect Quad Offset 10 kHz	MM/M	Value	Phase	ID Elect Quad Gain 10 kHz	Value	Phase	IM Elect Phase 10 kHz DEG	Value		
Before			23.35	Before		0.9643	Before		EXCEEDS LIMIT 13.55		
	-300.0 (Minimum)	0 (Nominal)	300.0 (Maximum)		0.8500 (Minimum)	1.000 (Nominal)	1.200 (Maximum)		-10.00 (Minimum)	0 (Nominal)	10.00 (Maximum)
Phase	IM Elect Real Offset 10 kHz	MM/M	Value	Phase	IM Elect Real Gain 10 kHz	Value	10kHz not used				
Before			97.69	Before		0.9506					
	-550.0 (Minimum)	0 (Nominal)	550.0 (Maximum)		0.8500 (Minimum)	1.000 (Nominal)	1.200 (Maximum)				

Phase	IM Elect Quad Offset 10 kHz MM/M	Value	Phase	IM Elect Quad Gain 10 kHz	Value
Before		96.41	Before		0.9483
	-550.0 (Minimum) 0 (Nominal) 550.0 (Maximum)			0.8500 (Minimum) 1.000 (Nominal) 1.200 (Maximum)	

Before: 15-Jan-2003 15:40

Dual Induction - E Wellsite Calibration

Induction Electronics (20 kHz)

Phase	ID Elect Real Offset 20 kHz MM/M	Value	Phase	ID Elect Real Gain 20 kHz	Value	Phase	ID Elect Phase 20 kHz DEG	Value
Before		14.96	Before		1.007	Before		9.501
	-125.0 (Minimum) 0 (Nominal) 125.0 (Maximum)			0.8500 (Minimum) 1.000 (Nominal) 1.200 (Maximum)			-15.00 (Minimum) 0 (Nominal) 15.00 (Maximum)	
Phase	ID Elect Quad Offset 20 kHz MM/M	Value	Phase	ID Elect Quad Gain 20 kHz	Value	Phase	IM Elect Phase 20 kHz DEG	Value
Before		9.431	Before		0.9950	Before		12.55
	-125.0 (Minimum) 0 (Nominal) 125.0 (Maximum)			0.8500 (Minimum) 1.000 (Nominal) 1.200 (Maximum)			-15.00 (Minimum) 0 (Nominal) 15.00 (Maximum)	
Phase	IM Elect Real Offset 20 kHz MM/M	Value	Phase	IM Elect Real Gain 20 kHz	Value	40kHz not used		
Before		40.85	Before		1.012			
	-225.0 (Minimum) 0 (Nominal) 225.0 (Maximum)			0.8500 (Minimum) 1.000 (Nominal) 1.200 (Maximum)				
Phase	IM Elect Quad Offset 20 kHz MM/M	Value	Phase	IM Elect Quad Gain 20 kHz	Value	40kHz not used		
Before		40.40	Before		1.009			
	-225.0 (Minimum) 0 (Nominal) 225.0 (Maximum)			0.8500 (Minimum) 1.000 (Nominal) 1.200 (Maximum)				

Before: 15-Jan-2003 15:41

Dual Induction - E Wellsite Calibration

Induction Electronics (40 kHz)

Phase	ID Elect Real Offset 40 kHz MM/M	Value	Phase	ID Elect Real Gain 40 kHz	Value	Phase	ID Elect Phase 40 kHz DEG	Value
Before		9.829	Before		0.9926	Before		EXCEEDS LIMIT 29.37
	-85.00 (Minimum) 0 (Nominal) 85.00 (Maximum)			0.8500 (Minimum) 1.000 (Nominal) 1.200 (Maximum)			-20.00 (Minimum) 0 (Nominal) 20.00 (Maximum)	
Phase	ID Elect Quad Offset 40 kHz MM/M	Value	Phase	ID Elect Quad Gain 40 kHz	Value	Phase	IM Elect Phase 40 kHz DEG	Value
Before		6.156	Before		0.9797	Before		EXCEEDS LIMIT 33.01
	-85.00 (Minimum) 0 (Nominal) 85.00 (Maximum)			0.8500 (Minimum) 1.000 (Nominal) 1.200 (Maximum)			-20.00 (Minimum) 0 (Nominal) 20.00 (Maximum)	
Phase	IM Elect Real Offset 40 kHz MM/M	Value	Phase	IM Elect Real Gain 40 kHz	Value	40kHz not used		
Before		26.65	Before		1.027			
	-130.0 (Minimum) 0 (Nominal) 130.0 (Maximum)			0.8500 (Minimum) 1.000 (Nominal) 1.200 (Maximum)				
Phase	IM Elect Quad Offset 40 kHz MM/M	Value	Phase	IM Elect Quad Gain 40 kHz	Value	40kHz not used		
Before		26.47	Before		1.024			
	-130.0 (Minimum) 0 (Nominal) 130.0 (Maximum)			0.8500 (Minimum) 1.000 (Nominal) 1.200 (Maximum)				

Before: 15-Jan-2003 15:42

Dual Induction - E Wellsite Calibration

SFL Electronics

Phase	SFL Voltage Offset MV	Value	Phase	SFL Voltage Gain	Value
Before		1.294	Before		1.021
	-15.00 (Minimum) 0 (Nominal) 15.00 (Maximum)			0.8500 (Minimum) 1.000 (Nominal) 1.200 (Maximum)	
Phase	SFL Current Offset MA	Value	Phase	SFL Current Gain	Value
Before		0.004236	Before		0.9971
	-0.6000 (Minimum) 0 (Nominal) 0.6000 (Maximum)			0.8500 (Minimum) 1.000 (Nominal) 1.200 (Maximum)	

Before: 15-Jan-2003 15:43

Dual Induction - E Wellsite Calibration

Electronics Calibration Changes Files/Depth Intervals: 4: 3166.1 - 3643.9 5: 3685.0 - 3164.4 6: 3685.0 - 3261.4

Phase	ID (R > 27 OHM-M) MM/M	Value	Phase	ID (R < 27 OHM-M) %	Value	Phase	SFL (R < 1 OHM-M) OHMM	Value
After		0	After		0.0001666	After		0.0004445
	0 (Minimum) 0 (Nominal) 0.7500 (Maximum)			0 (Minimum) 0 (Nominal) 2.000 (Maximum)			0 (Minimum) 0 (Nominal) 0.02000 (Maximum)	

Phase	IM (R > 27 OHM-M) MM/M	Value	Phase	IM (R < 27 OHM-M) %	Value
After		0	After		0.0001334
0 (Minimum)	1.000 (Nominal)	0.7500 (Maximum)	0 (Minimum)	0 (Nominal)	2.000 (Maximum)
Phase	SFL (R > 27 OHM-M) MM/M	Value	Phase	SFL (R < 27 OHM-M) %	Value
After		0	After		0.0004537
0 (Minimum)	1.000 (Nominal)	0.7500 (Maximum)	0 (Minimum)	0 (Nominal)	2.000 (Maximum)

After: 31-Jan-2003 10:50

Dual Induction - E Master Calibration											
Test Loop Calibration: Calibration of Internal Reference to Test Loop Standard											
Phase	Deep 10 kHz Gain Factor		Value	Phase	Deep 20 kHz Gain Factor		Value	Phase	Deep 40 kHz Gain Factor		Value
Master			0.9956	Master			1.008	Master			1.026
0.9000 (Minimum)	1.000 (Nominal)	1.100 (Maximum)		0.9000 (Minimum)	1.000 (Nominal)	1.100 (Maximum)		0.9000 (Minimum)	1.000 (Nominal)	1.100 (Maximum)	
Phase	Medium 10 kHz Gain Factor		Value	Phase	Medium 20 kHz Gain Factor		Value	Phase	Medium 40 kHz Gain Factor		Value
Master			1.022	Master			1.030	Master			1.061
0.9000 (Minimum)	1.000 (Nominal)	1.100 (Maximum)		0.9000 (Minimum)	1.000 (Nominal)	1.100 (Maximum)		0.9000 (Minimum)	1.000 (Nominal)	1.100 (Maximum)	
Phase	Deep 10 kHz Phase Shift		Value	Phase	Deep 20 kHz Phase Shift		Value	Phase	Deep 40 kHz Phase Shift		Value
Master			0.1143	Master			-0.1524	Master			-1.426
-1.500 (Minimum)	0 (Nominal)	1.500 (Maximum)		-2.000 (Minimum)	0 (Nominal)	2.000 (Maximum)		-4.000 (Minimum)	-1.000 (Nominal)	2.000 (Maximum)	
Phase	Medium 10 kHz Phase Shift		Value	Phase	Medium 20 kHz Phase Shift		Value	Phase	Medium 40 kHz Phase Shift		Value
Master			-0.2558	Master			-0.9331	Master			-2.461
-1.500 (Minimum)	0 (Nominal)	1.500 (Maximum)		-3.000 (Minimum)	-1.000 (Nominal)	1.000 (Maximum)		-5.000 (Minimum)	-2.000 (Nominal)	1.000 (Maximum)	

Master: Calibration out of date 5-Oct-2001 20:50

Dual Induction - E Master Calibration											
Sonde Error Corrections: Correction for sonde response in zero conductivity environment. (Normalized to 25C).											
Phase	Real Deep 10 kHz S.E. Corr.		Value	Phase	Real Deep 20 kHz S.E. Corr.		Value	Phase	Real Deep 40 kHz S.E. Corr.		Value
Master			44.95	Master			16.36	Master			4.690
-50.00 (Minimum)	0 (Nominal)	125.0 (Maximum)		-30.00 (Minimum)	0 (Nominal)	30.00 (Maximum)		-15.00 (Minimum)	0 (Nominal)	15.00 (Maximum)	
Phase	Quad Deep 10 kHz S.E. Corr.		Value	Phase	Quad Deep 20 kHz S.E. Corr.		Value	Phase	Quad Deep 40 kHz S.E. Corr.		Value
Master			108.9	Master			64.63	Master			46.10
-250.0 (Minimum)	0 (Nominal)	350.0 (Maximum)		-125.0 (Minimum)	0 (Nominal)	200.0 (Maximum)		-75.00 (Minimum)	0 (Nominal)	125.0 (Maximum)	
Phase	Real Medium 10 kHz S.E. Corr.		Value	Phase	Real Medium 20 kHz S.E. Corr.		Value	Phase	Real Medium 40 kHz S.E. Corr.		Value
Master			20.73	Master			-1.786	Master			-10.46
-50.00 (Minimum)	0 (Nominal)	140.0 (Maximum)		-50.00 (Minimum)	0 (Nominal)	50.00 (Maximum)		-30.00 (Minimum)	0 (Nominal)	30.00 (Maximum)	
Phase	Quad Medium 10 kHz S.E. Corr.		Value	Phase	Quad Medium 20 kHz S.E. Corr.		Value	Phase	Quad Medium 40 kHz S.E. Corr.		Value
Master			-105.8	Master			-34.20	Master			11.45
-1300 (Minimum)	0 (Nominal)	1300 (Maximum)		-650.0 (Minimum)	0 (Nominal)	650.0 (Maximum)		-350.0 (Minimum)	0 (Nominal)	350.0 (Maximum)	

Master: Calibration out of date 5-Oct-2001 21:22

### Hostile Litho-Density Sonde / Equipment Identification

#### Primary Equipment:

Hostile Litho Density Sonde	HLDS - D	45
Hostile Litho Density High Voltage	HLDV - D	35
Gamma Source Radioactive	GSR - Z	1846

#### Auxiliary Equipment:

Hostile Litho Density Pad	HLDP - C	45
Hostile Litho Density High Voltage Housi	HEH - H	35

### Nuclear Porosity Lithology Cartridge - B / Equipment Identification

#### Primary Equipment:

NPLC Cartridge

NPLC - B

79

Auxiliary Equipment:  
NPLC Housing

NPH - B

82

Accelerator-Porosity Tool / Equipment Identification

Primary Equipment:

Accelerator-Porosity Sonde  
APS Minitron

APS - BA  
MNTR - F

22  
4185

Auxiliary Equipment:

Accelerator-Porosity Housing  
APS Calibration Water Tank  
APS Aluminium Calibrator Sleeve

APH - AC  
SFT - 178  
SFT - 281

22  
4722  
24

Hostile Natural Gamma Ray Sonde / Equipment Identification

Primary Equipment:

HNGS Sonde

HNGS - BA

77

Auxiliary Equipment:

HNGS Sonde Housing  
Gamma Source Radioactive

HNSH - BA  
GSR - U

79  
135

Hostile Natural Gamma Ray Sonde Wellsite Calibration

Detector 1 Check

Phase	Na 511 Peak Loc	Value	Phase	Na 511 Peak Res %	Value	Phase	High Voltage V	Value
Master		40.59	Master		17.05	Master		1212
Before		40.72	Before		17.42	Before		1212
After		40.59	After		16.56	After		1214
	37.50 (Minimum) 40.00 (Nominal) 42.50 (Maximum)			12.00 (Minimum) 15.50 (Nominal) 19.00 (Maximum)			900.0 (Minimum) 1150 (Nominal) 1600 (Maximum)	
Phase	Na 1785 Peak Loc	Value	Phase	Na 1785 Peak Res %	Value	Phase	Temperature DEGC	Value
Master		145.6	Master		9.037	Master		32.69
Before		145.3	Before		9.666	Before		32.84
After		145.7	After		8.507	After		29.39
	135.0 (Minimum) 142.6 (Nominal) 150.3 (Maximum)			7.000 (Minimum) 8.500 (Nominal) 11.00 (Maximum)			-28.89 (Minimum) 15.50 (Nominal) 60.00 (Maximum)	
Phase	Na Count Rate CPS	Value						
Master		44.80						
Before		43.98						
After		42.72						
	10.00 (Minimum) 45.00 (Nominal) 100.0 (Maximum)							
Master: 15-Jan-2003 16:08			Before: 15-Jan-2003 16:17			After: 31-Jan-2003 17:06		

Hostile Natural Gamma Ray Sonde Wellsite Calibration

Detector 2 Check

Phase	Na 511 Peak Loc	Value	Phase	Na 511 Peak Res %	Value	Phase	High Voltage V	Value
Master		40.55	Master		16.60	Master		1239
Before		40.57	Before		16.91	Before		1239
After		40.60	After		16.65	After		1242
	37.50 (Minimum) 40.00 (Nominal) 42.50 (Maximum)			12.00 (Minimum) 15.50 (Nominal) 19.00 (Maximum)			900.0 (Minimum) 1150 (Nominal) 1600 (Maximum)	
Phase	Na 1785 Peak Loc	Value	Phase	Na 1785 Peak Res %	Value	Phase	Temperature DEGC	Value
Master		144.7	Master		9.925	Master		32.80
Before		144.4	Before		9.708	Before		32.89
After		144.6	After		9.652	After		29.19

Phase	Na Count Rate CPS	Value
Master		44.45
Before		43.98
After		42.38
	10.00 (Minimum) 45.00 (Nominal) 100.0 (Maximum)	

Master: 15-Jan-2003 16:08      Before: 15-Jan-2003 16:17      After: 31-Jan-2003 17:06

Hostile Natural Gamma Ray Sonde Wellsite Calibration		
Ratio Of Detector 1 To Detector 2		
Phase	Coincidence Count Rate Ratio	Value
Master		1.008
Before		1.0000
After		1.006
	0.9500 (Minimum) 1.000 (Nominal) 1.050 (Maximum)	

Master: 15-Jan-2003 16:08  
Before: 15-Jan-2003 16:17  
After: 31-Jan-2003 17:06

Hostile Natural Gamma Ray Sonde Master Calibration									
Detector 1 Calibration									
Phase	Na 511 Peak Set Point	Value	Phase	Th Peak Loc	Value	Phase	Th Peak Res %	Value	
Master		41.00	Master		209.3	Master		8.207	
	38.00 (Minimum) 40.00 (Nominal) 42.00 (Maximum)			201.0 (Minimum) 209.6 (Nominal) 218.3 (Maximum)			5.000 (Minimum) 7.000 (Nominal) 9.000 (Maximum)		
Phase	Background Count Rate CPS	Value	Phase	Gain Ratio	Value				
Master		23.15	Master		0.9810				
	20.00 (Minimum) 142.5 (Nominal) 265.0 (Maximum)			0.9400 (Minimum) 1.000 (Nominal) 1.060 (Maximum)					

Master: 15-Jan-2003 16:01

Hostile Natural Gamma Ray Sonde Master Calibration									
Detector 2 Calibration									
Phase	Na 511 Peak Set Point	Value	Phase	Th Peak Loc	Value	Phase	Th Peak Res %	Value	
Master		41.00	Master		209.3	Master		7.848	
	38.00 (Minimum) 40.00 (Nominal) 42.00 (Maximum)			201.0 (Minimum) 209.6 (Nominal) 218.3 (Maximum)			5.000 (Minimum) 7.000 (Nominal) 9.000 (Maximum)		
Phase	Background Count Rate CPS	Value	Phase	Gain Ratio	Value				
Master		21.80	Master		0.9821				
	20.00 (Minimum) 142.5 (Nominal) 265.0 (Maximum)			0.9400 (Minimum) 1.000 (Nominal) 1.060 (Maximum)					

Master: 15-Jan-2003 16:01

Company: Lamont Doherty

Well: ODP Leg 207 Site 1258C

Field: Demarara Rise

Country: Venezuela

Ocean: Atlantic



Phasor Induction

Natural Gamma Ray